

PERFILES ARQUITECTONICOS

Línea

EUROVENT

Ponemos también a su disposición:

Línea PANORAMA SM

*Todo tipo de herrajes y accesorios
Película de seguridad y decorativas
Acrílicos, Policarbonatos,
Mayoristas en Paneles de Aluminio.*



CUPRUM

WhatsApp  55 5658-1700

División del Norte #2639 Col. del Carmen, Coyoacán.

 55 5658-1700 •  55 5658-1030 •  55 5658-0422 •  55 5658-0440  ventas@alucentro.mx

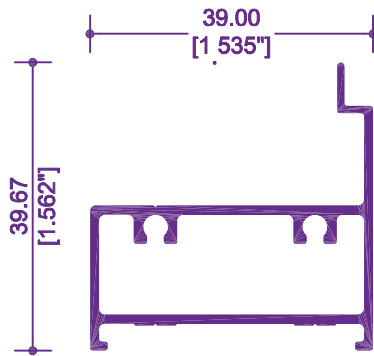

3501 / 12273
CONTRAMARCO

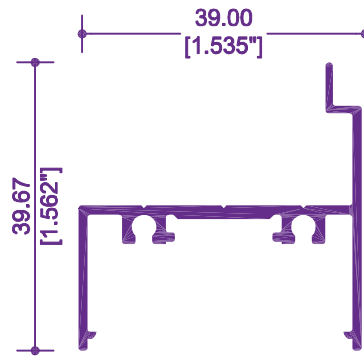

3505 / 13363
CONTRAMARCO

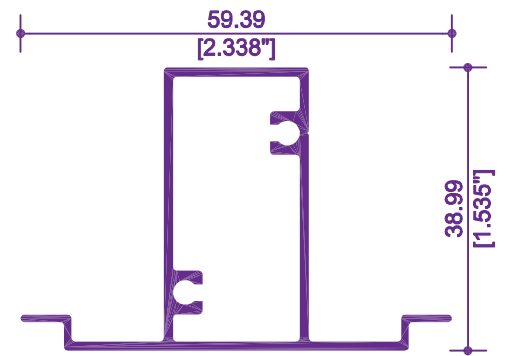

3502 / 12275
INTERMEDIO

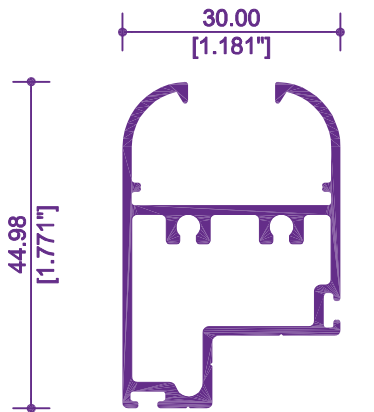

3503 / 12274
MARCO COLONIAL

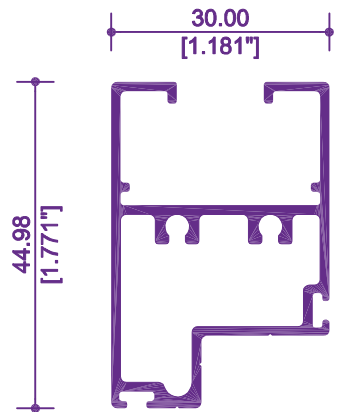

3504 / 12276
MARCO

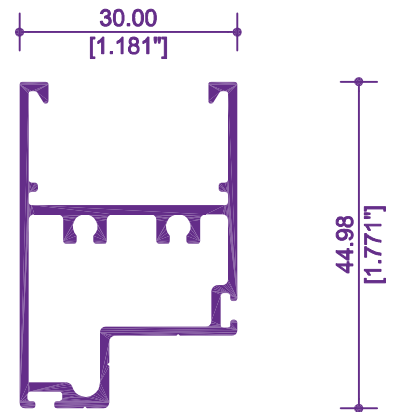

3506 / 12277
MARCO DOBLE VIDRIO

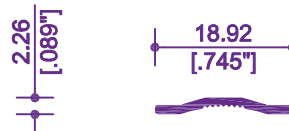

3509 / 81642
CUADRÍCULA INGLESA EXPUESTA

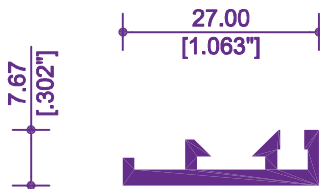

254 / 5173
MOSQUITERO

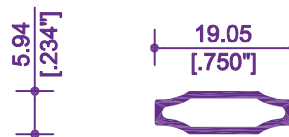

3508 / 12393
CUADRÍCULA INGLESA DOBLE VIDRIO

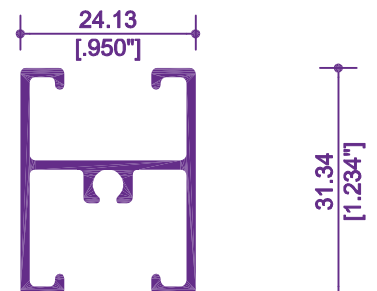

7045 / 12456
INTERMEDIO



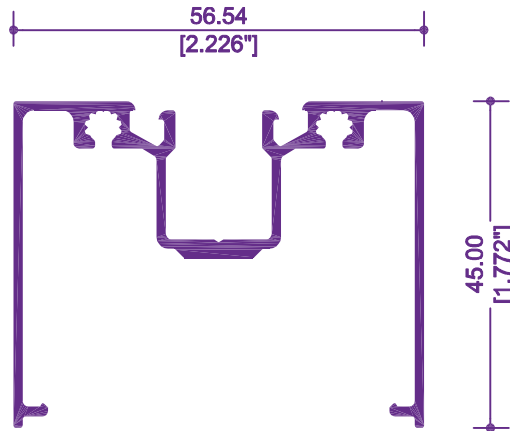

5025 / 12504
BOLSA

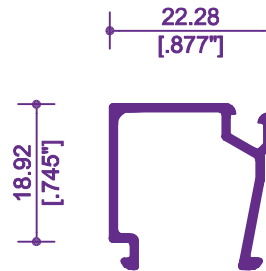

5023 / 12507
JUNQUILLO

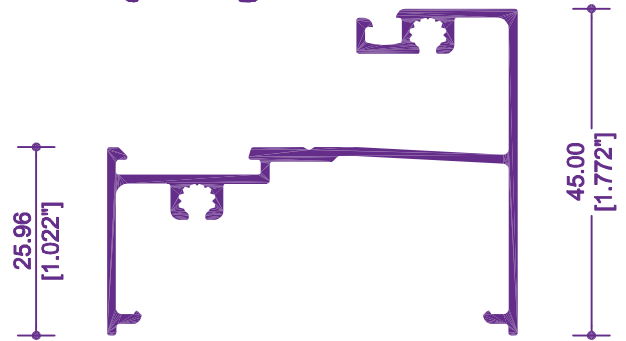

5024 / 12513
ESCALONADO INTERIOR

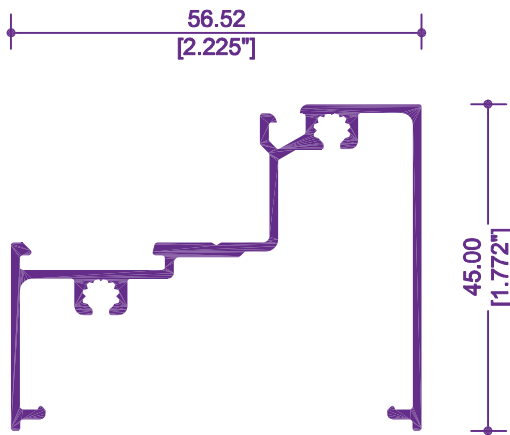

5022 / 12506
ESCALONADO EXTERIOR

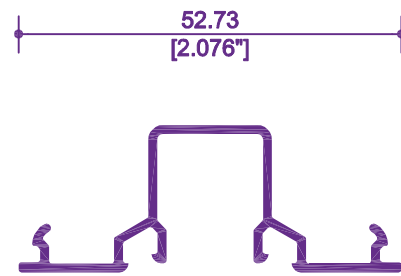

5027 / 12505
TAPA BOLSA



alucentro

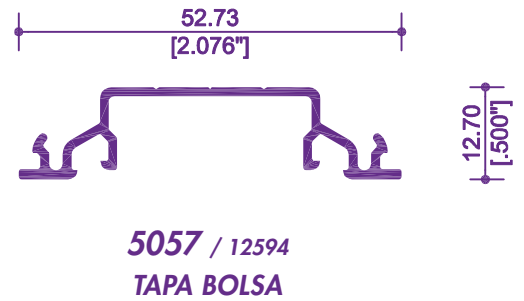
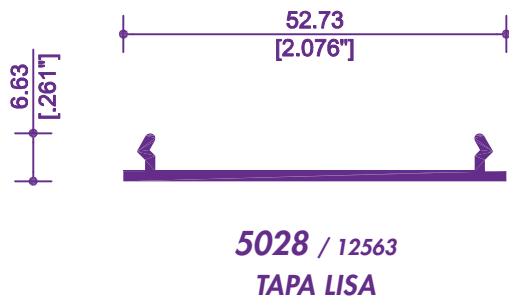
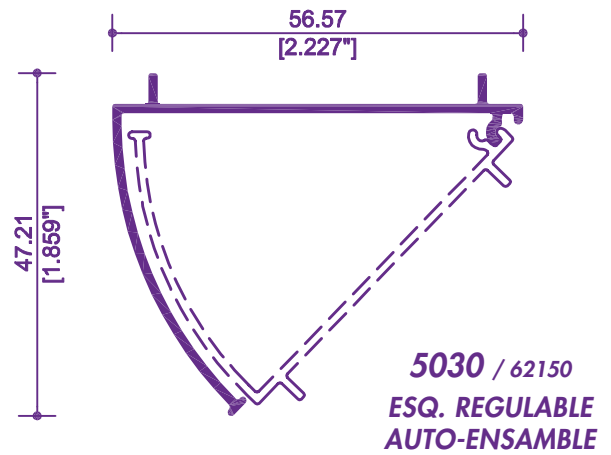
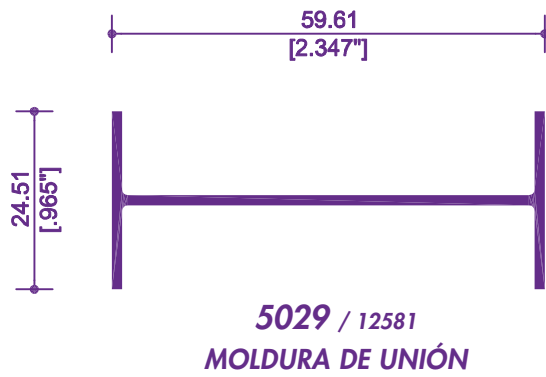
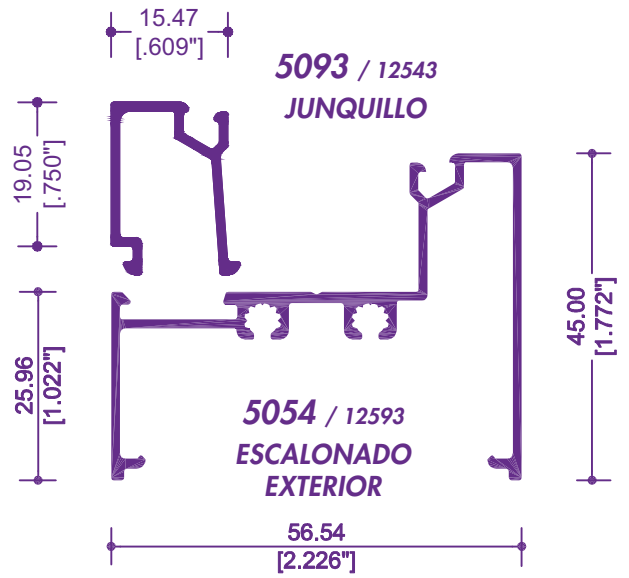
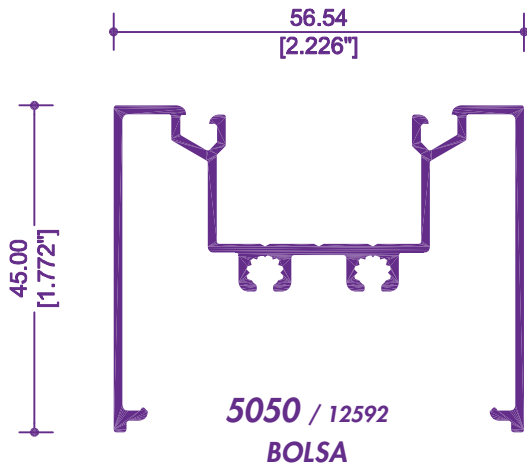

PUERTA BATIENTE COMERCIAL SERIE 50

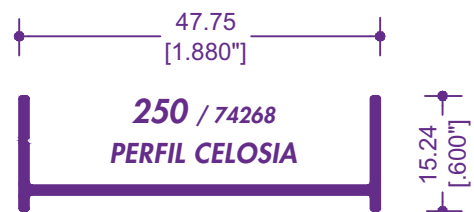
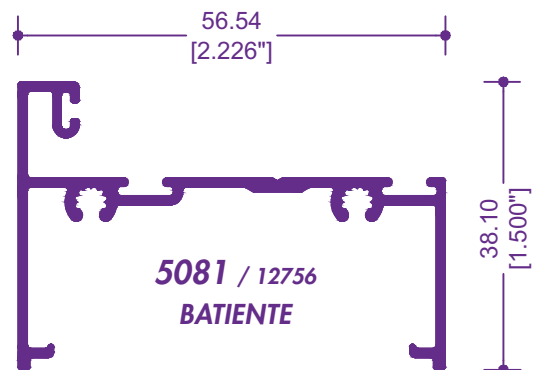
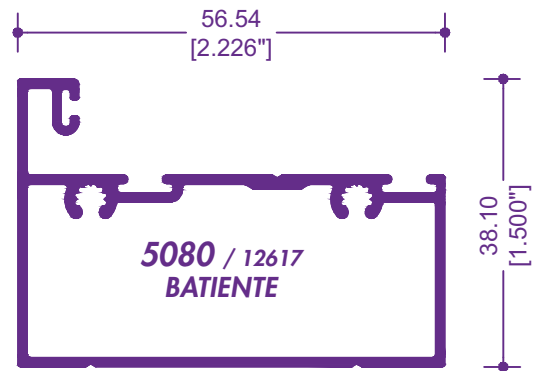
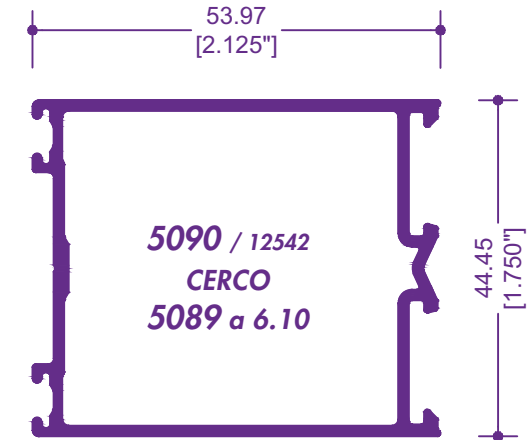
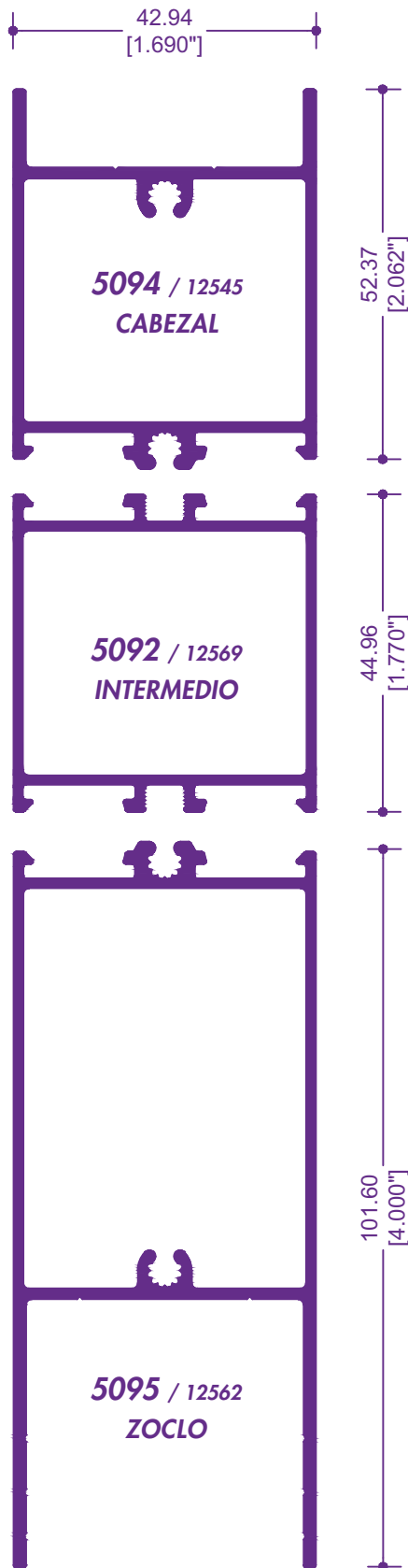

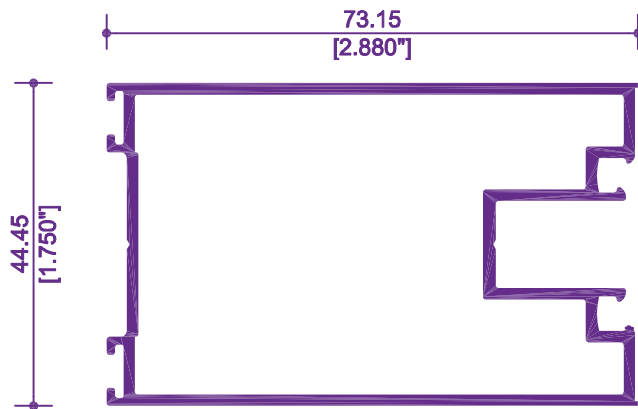

5096 / 14386
CERCO CON
JUNQUILLO INTEGRADO

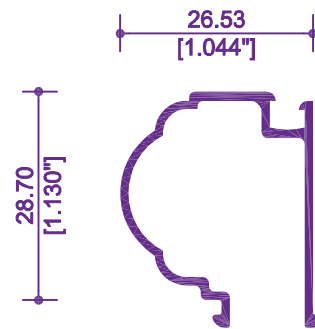

5086 / 12595
JUNQUILLO ALTO RELIEVE

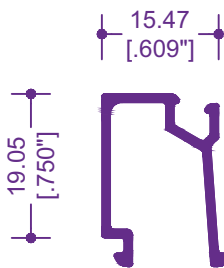

5093 / 12543
JUNQUILLO

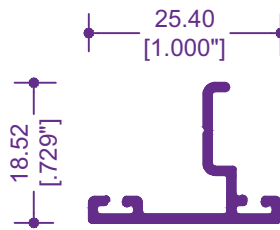

5082 / 74272
TOPE RECTO

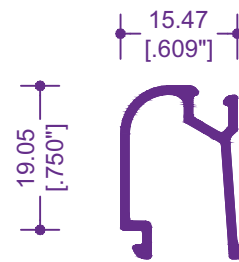

5085 / 12576
JUNQUILLO COLONIAL

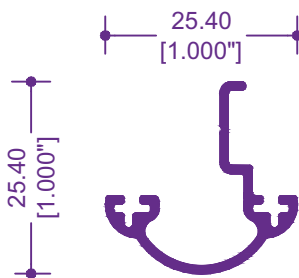

5084 / 12653
ADAPTADOR INTERMEDIO

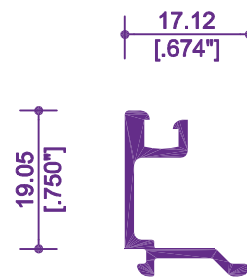

5083 / 12603
JUNQUILLO
DOBLE VIDRIO



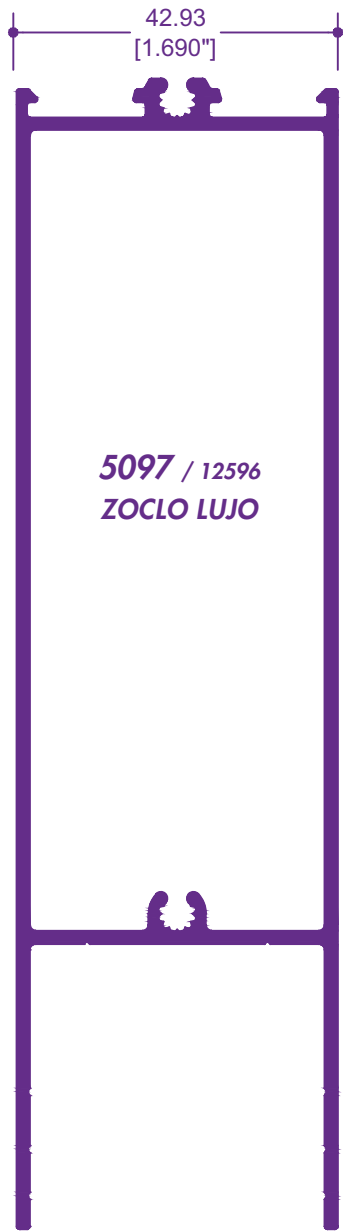

152.40
[6.000"]



25.40
[1.000"]

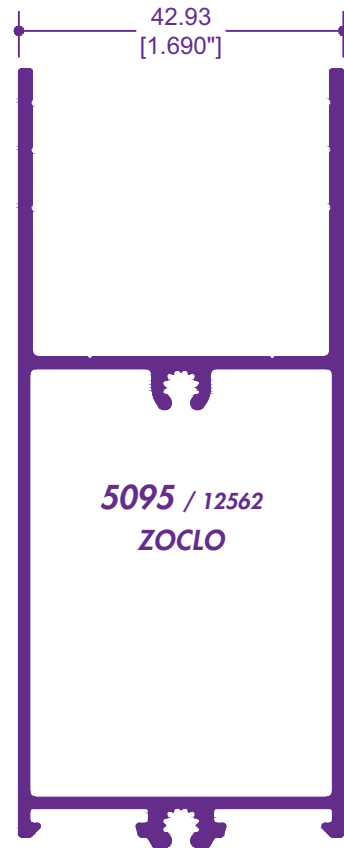

101.60
[4.000"]



101.60
[4.000"]



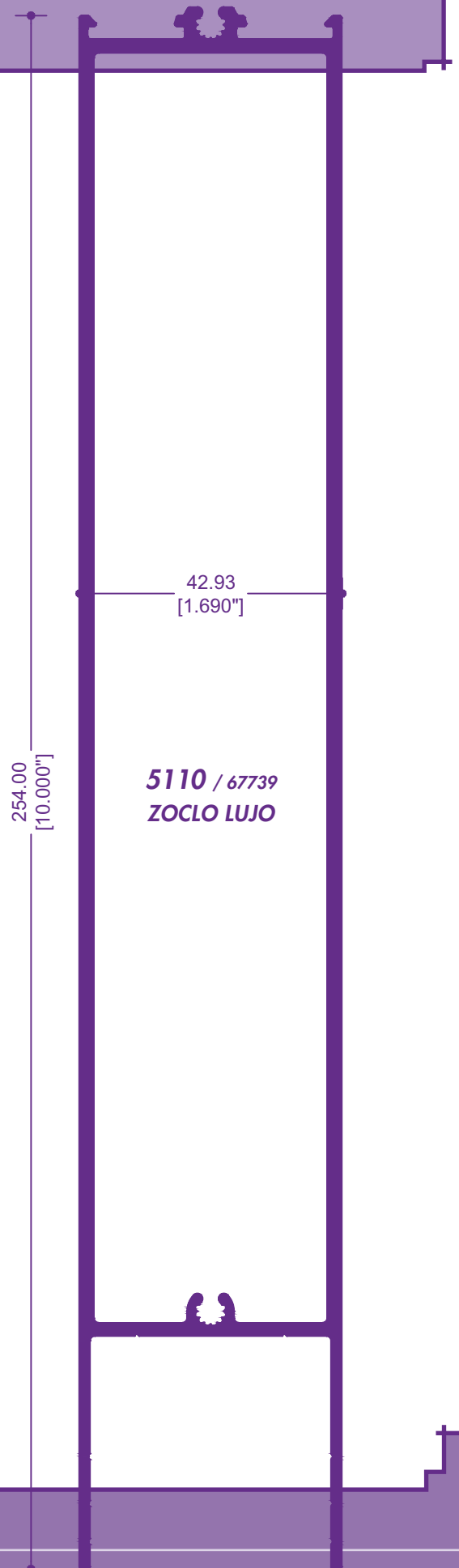
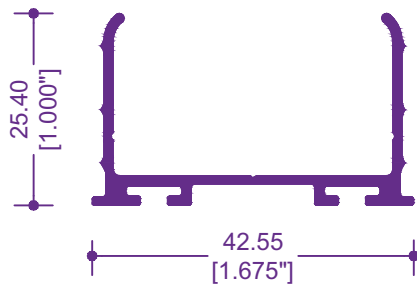
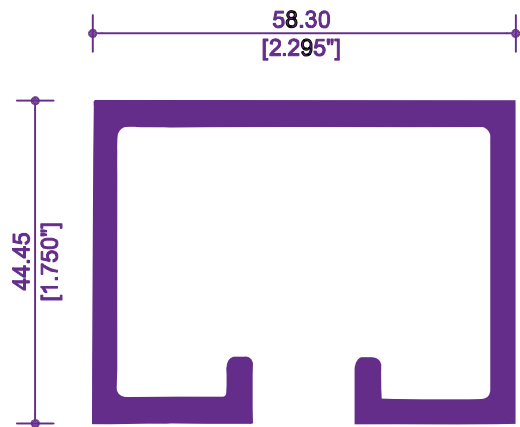
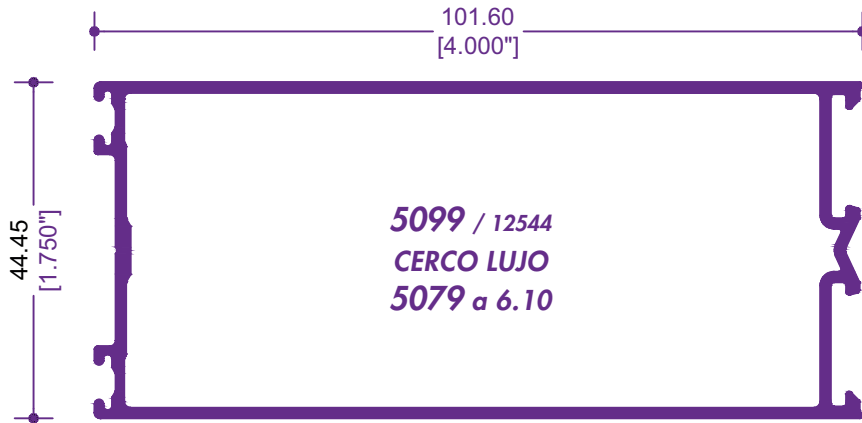



TABLA DE DESCUENTOS
PUERTA BATIENTE 1HOJA

CLAVE	CLAVE	DESCRIPCIÓN	No. DE PIEZAS	CORTE Y DESCUENTO
5080	12617	BATIENTE	1	L-51
5080	12617	BATIENTE	2	H
5099	12544	CERCO DE LUJO	2	H-44
5097	12596	ZOCLO DE LUJO	2	L-268
5092	12569	INTERMEDIO	6	L/2-154
5092	12569	INTERMEDIO	1	H-349
5086	12595	J/ALTO RELIEVE	32	L/2-146
5086	12595	J/ALTO RELIEVE	32	H/4-112
5087	12566	S HERMETICIDAD	2	L-73
	VIDRIO	L		L/2-165
		H	2	H/4-130
L= ANCHO DE VENTANA H= ALTO DE VENTANA			DESCUENTOS EN MM.	





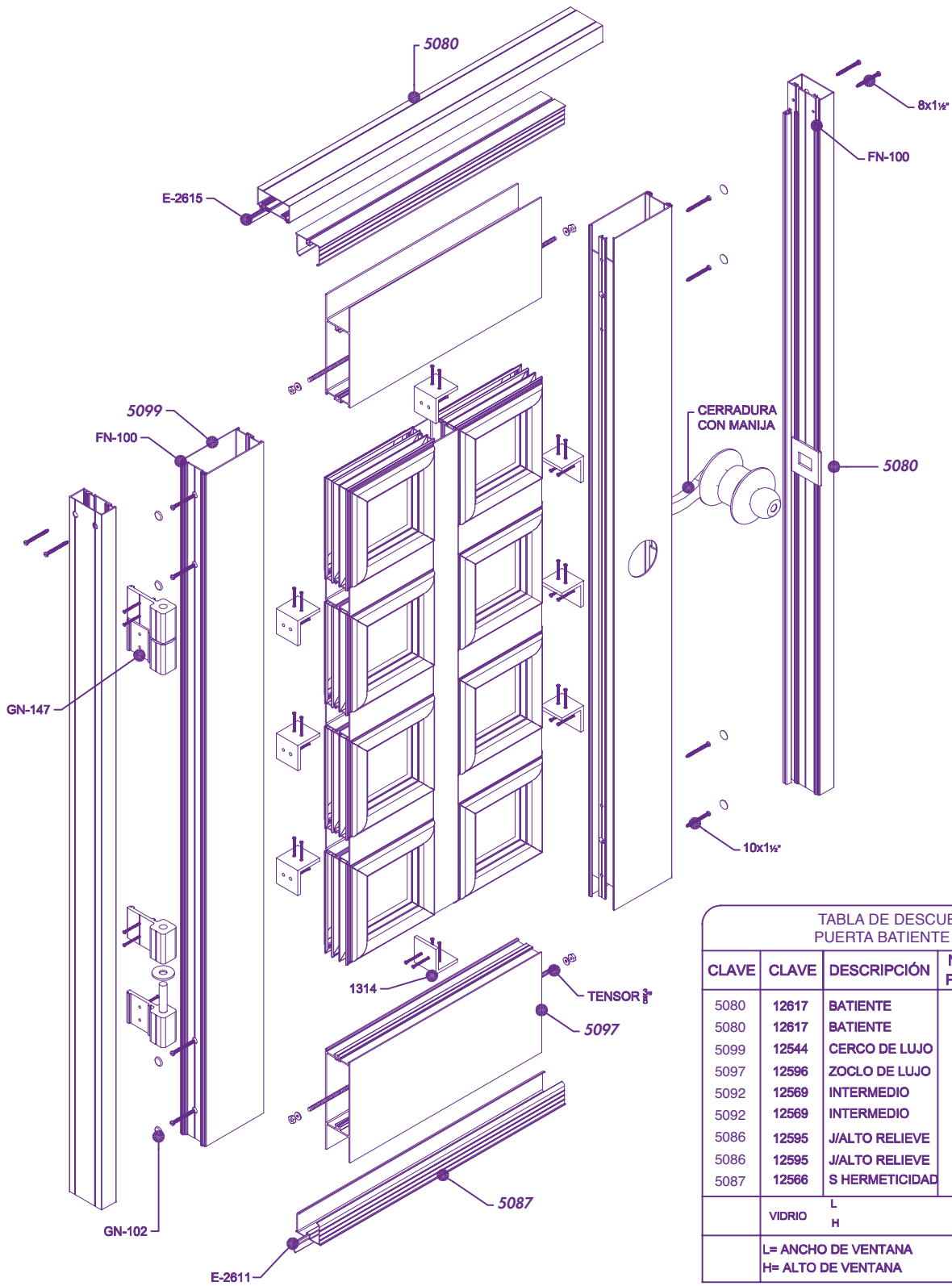
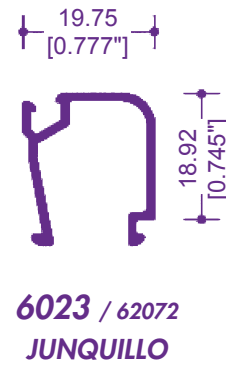
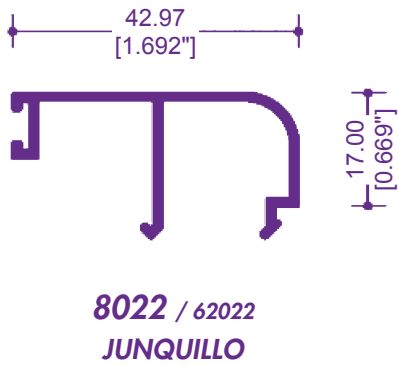
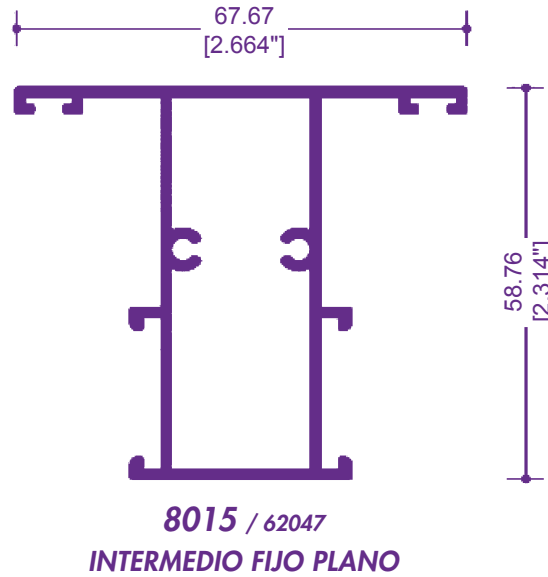
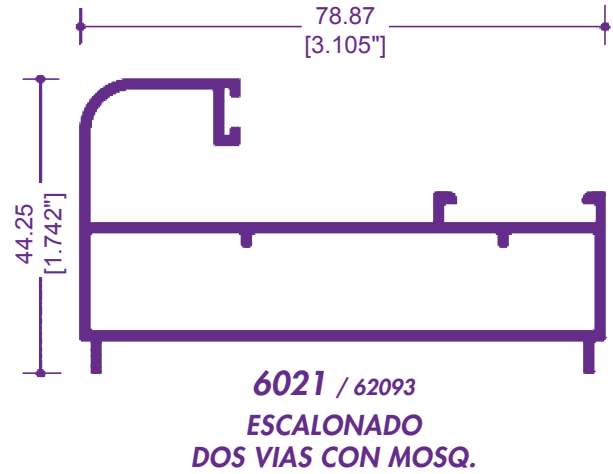
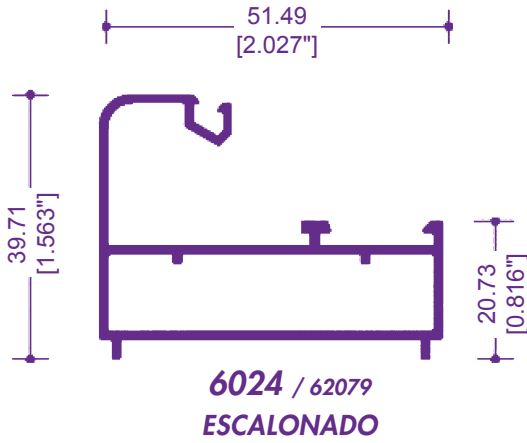
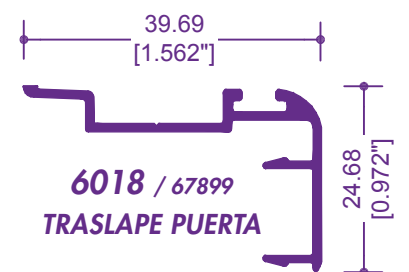
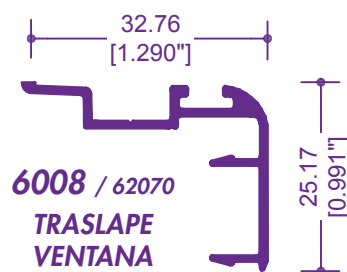
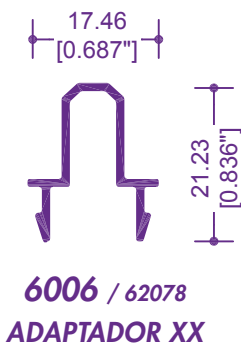
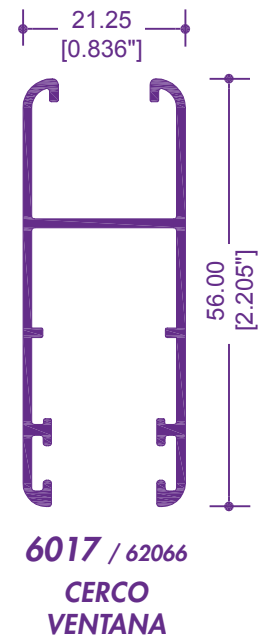
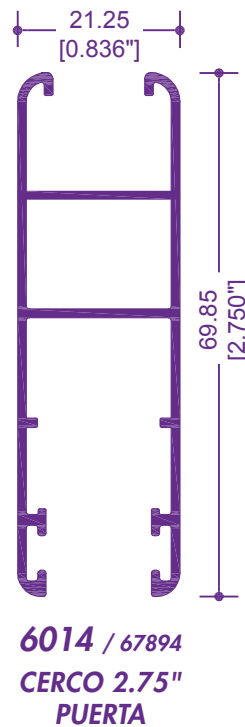
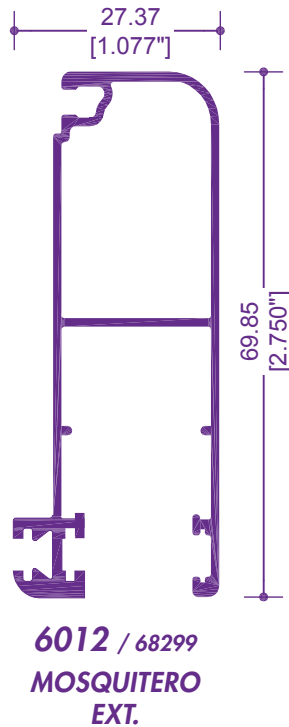
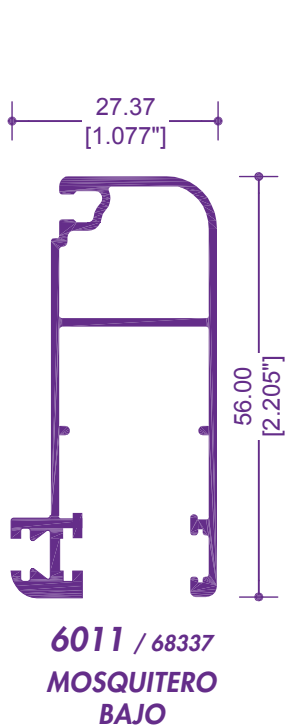
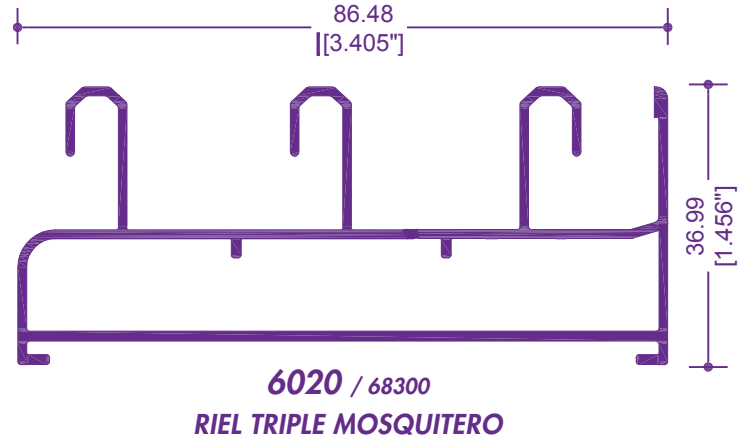
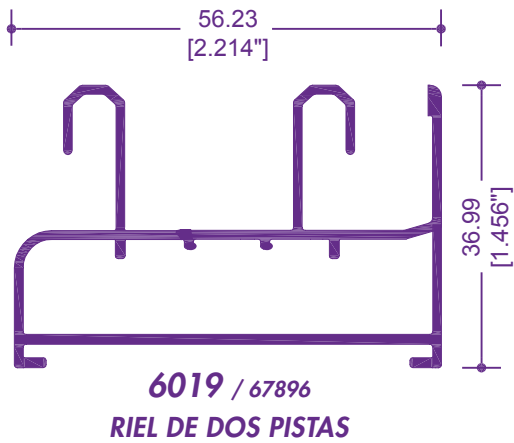

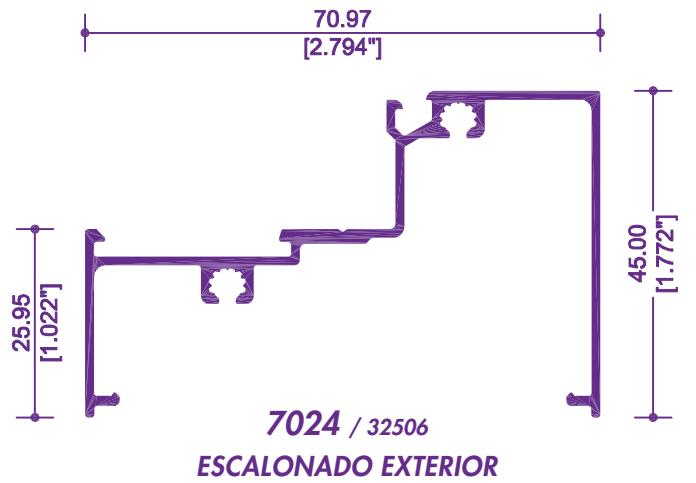
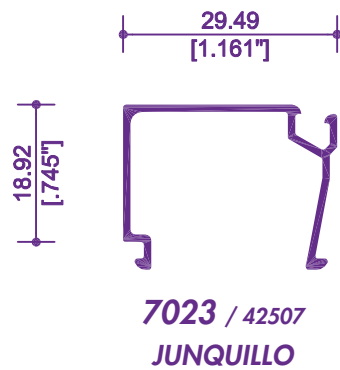
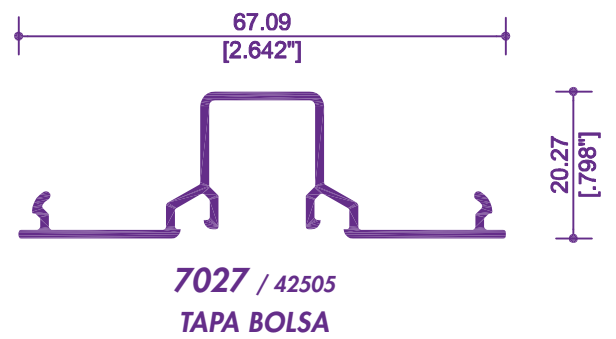
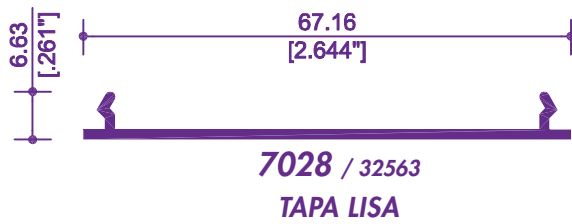
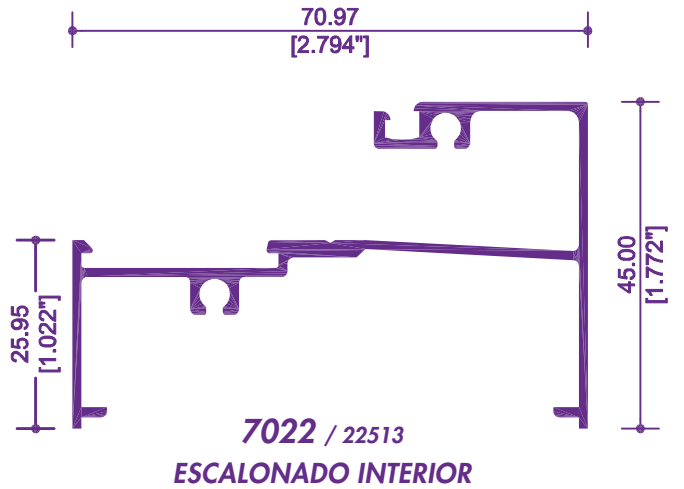
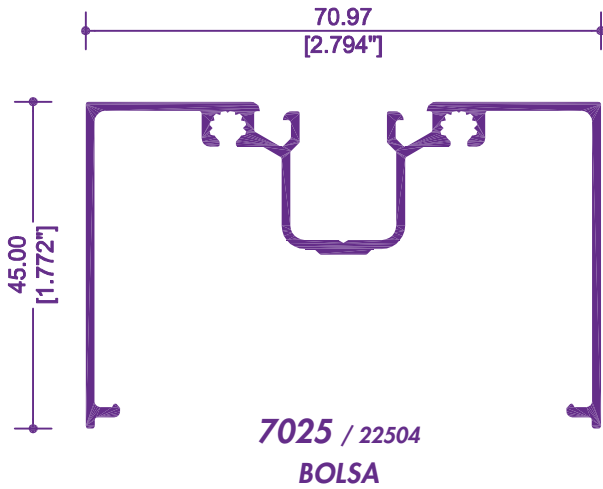

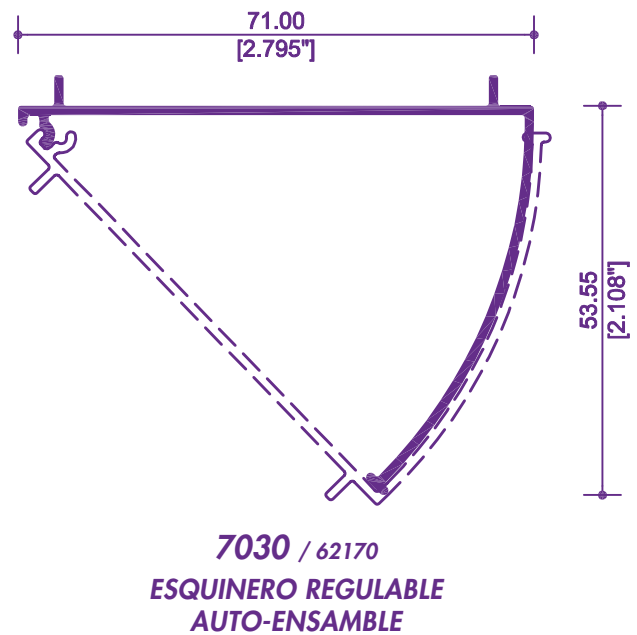
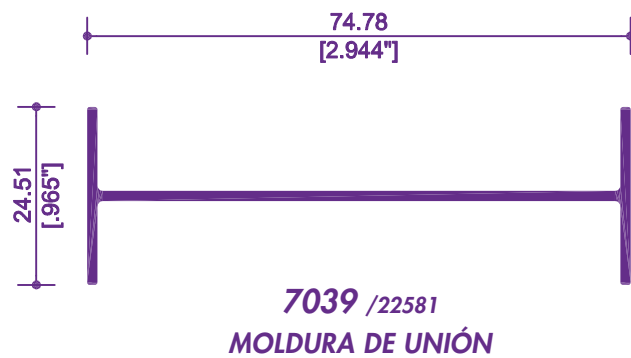
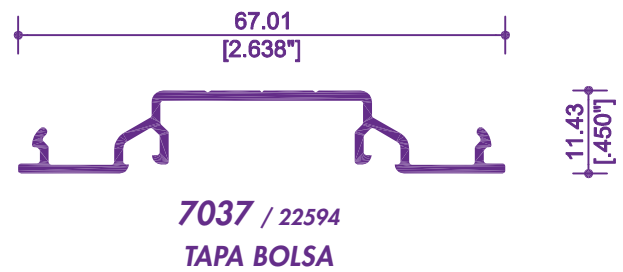
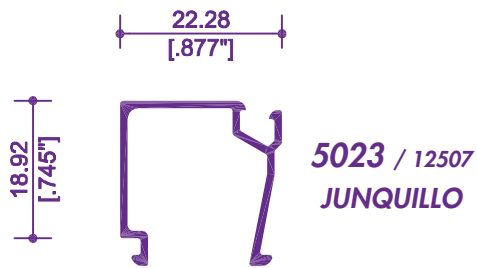
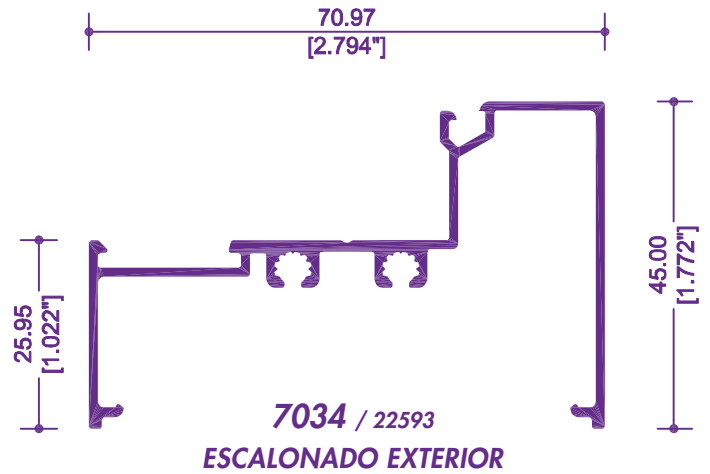
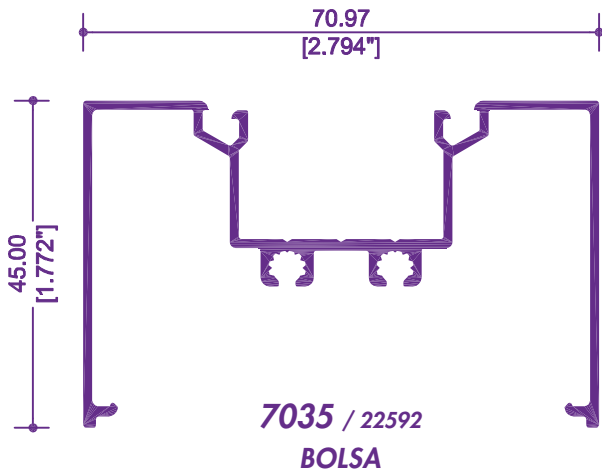

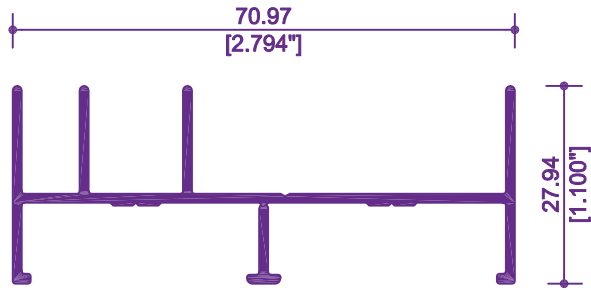

7040 /78408
JAMBA

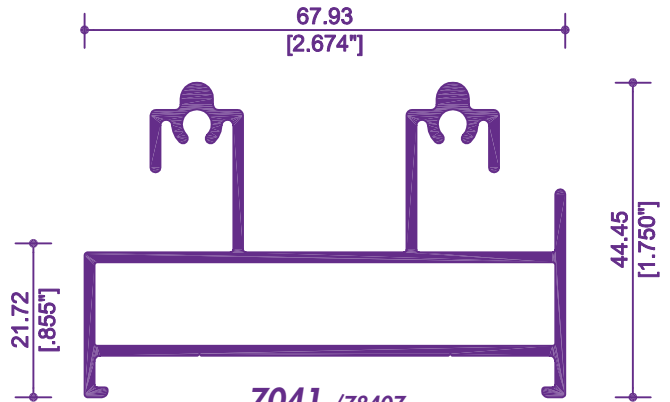

7041 /78407
RIEL-CABEZAL

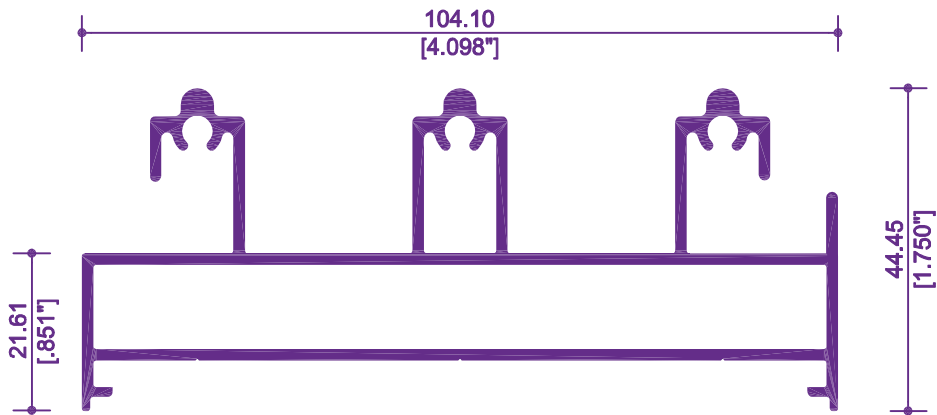

7059 /72373
RIEL TRIPLE

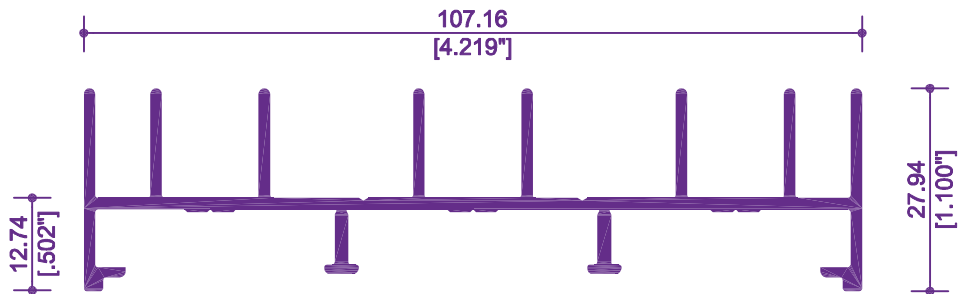

7050 /62374
JAMBA



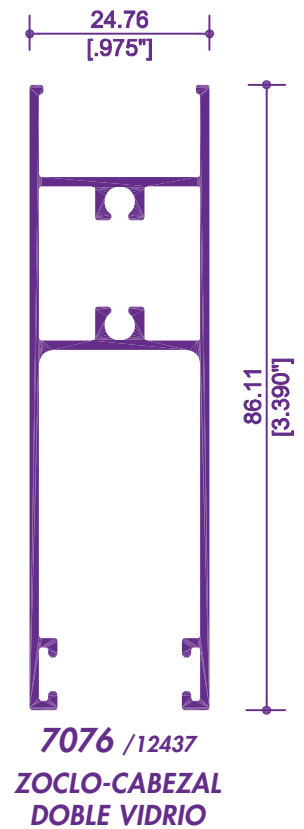
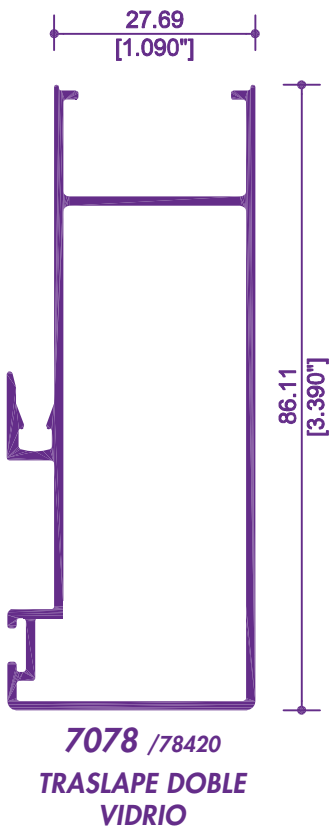
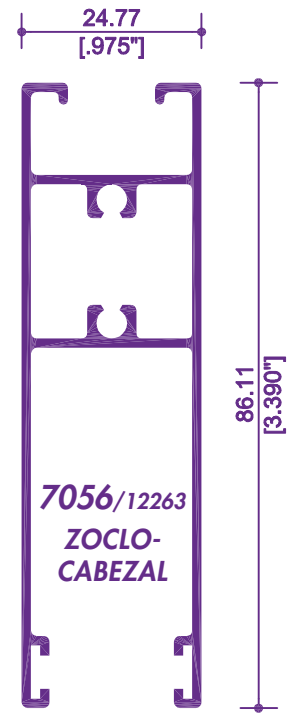
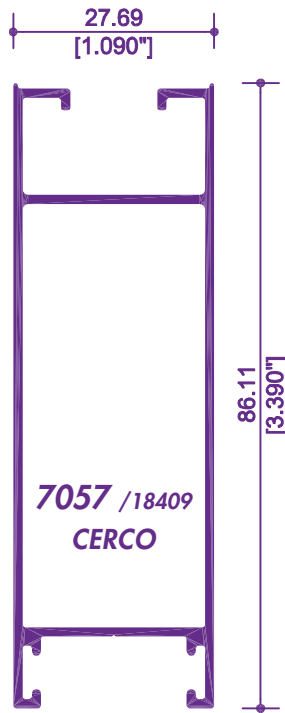
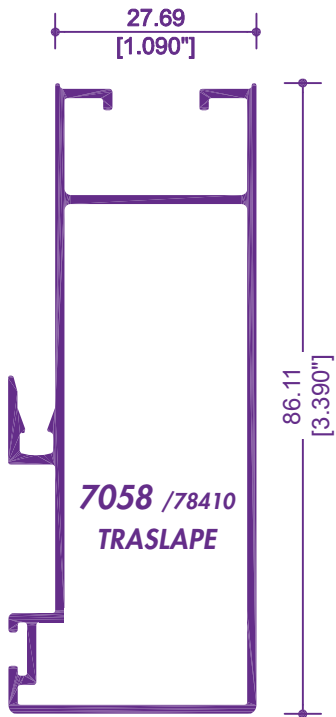

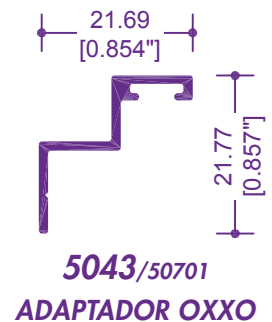
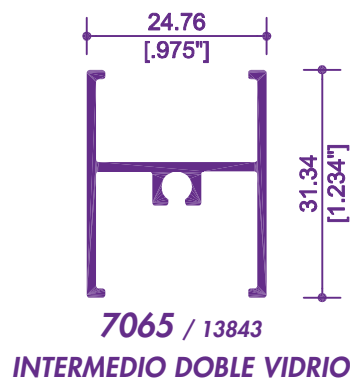
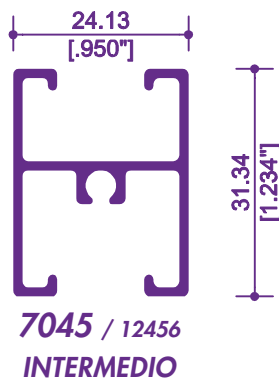
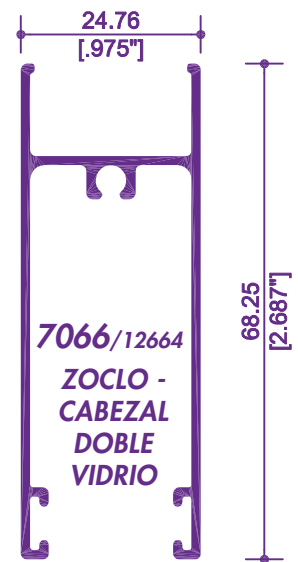
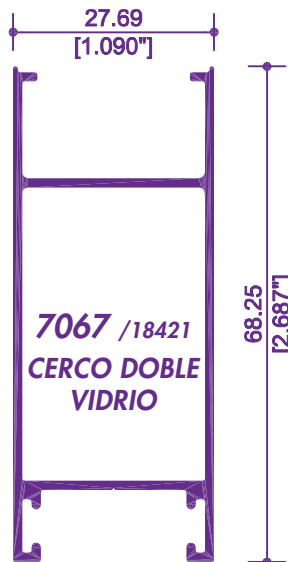
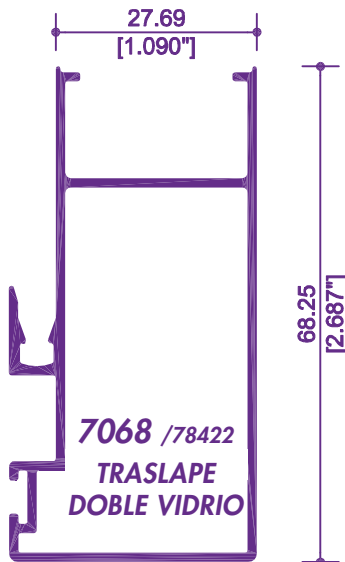
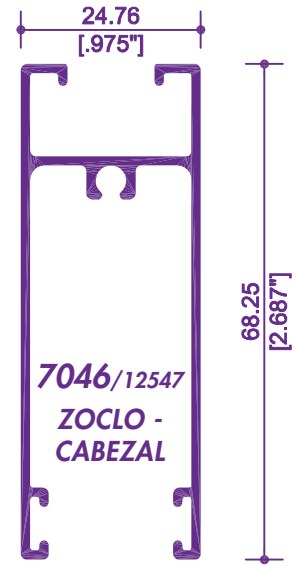
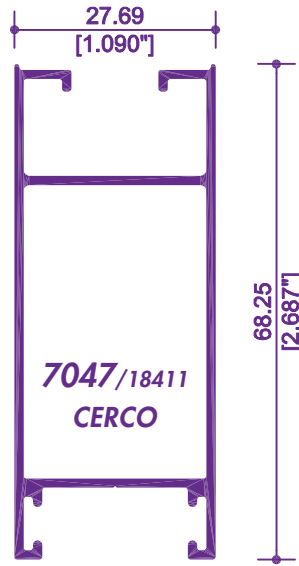
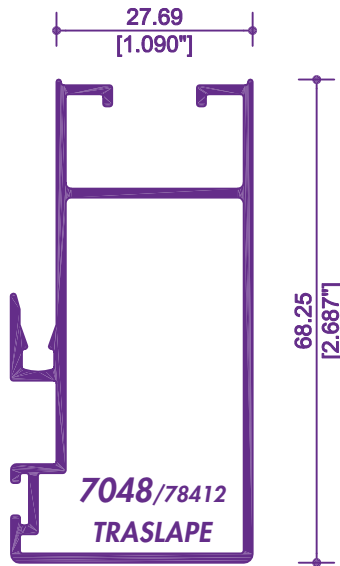

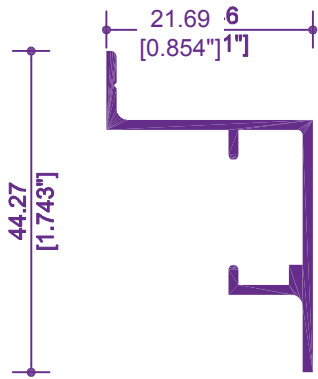

7080 / 11409
CABEZAL MOSQUITERO

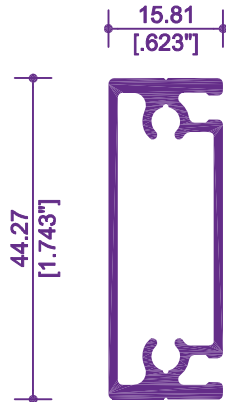

7084 / 11411
MOSQUITERO

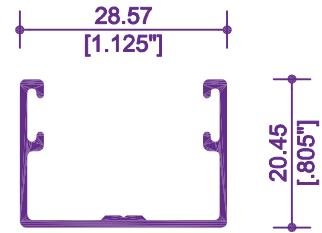

7082 / 18413
GUÍA INFERIOR

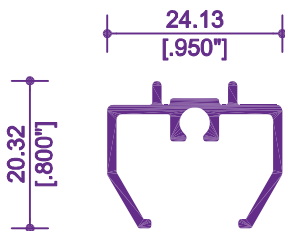

7085 / 14702
PERFIL P/ CUADRÍCULA

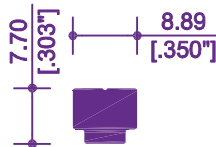

8035 / 14412
CONECTOR REFUERZO

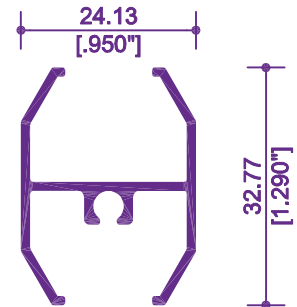

7086 / 14918
PERFIL P/ CUADRÍCULA

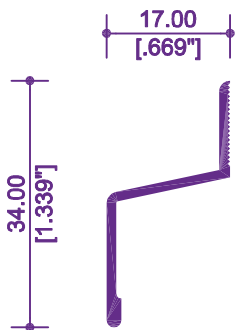

7081 / 12428
BOTAGUAS

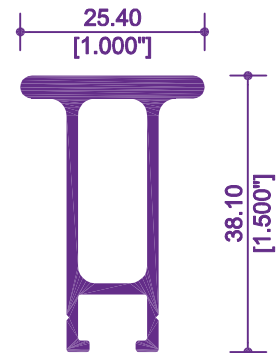

7038 / 14411
REFUERZO 1 1/2"





TABLA DE DESCUENTOS VENTANA

CLAVE	CLAVE	DESCRIPCIÓN	No. DE PIEZAS	CORTE Y DESCUENTO
7041	78407	RIEL-CABEZAL	2	L-26
7040	78408	JAMBA	2	H
7047	18411	CERCO	2	H-66
7046	12547	CABEZAL-ZOCLO	4	L/2
7048	78412	TRASLAPE	2	H-66
	VIDRIO	L	2	L/2-100
		H		H-189
L = ANCHO DE CANCEL H = ALTO DE CANCEL				DESCUENTOS (MM.)

NOTA:

LOS DESCUENTOS APLICAN PARA LOS PERFILES DOBLE VIDRIO

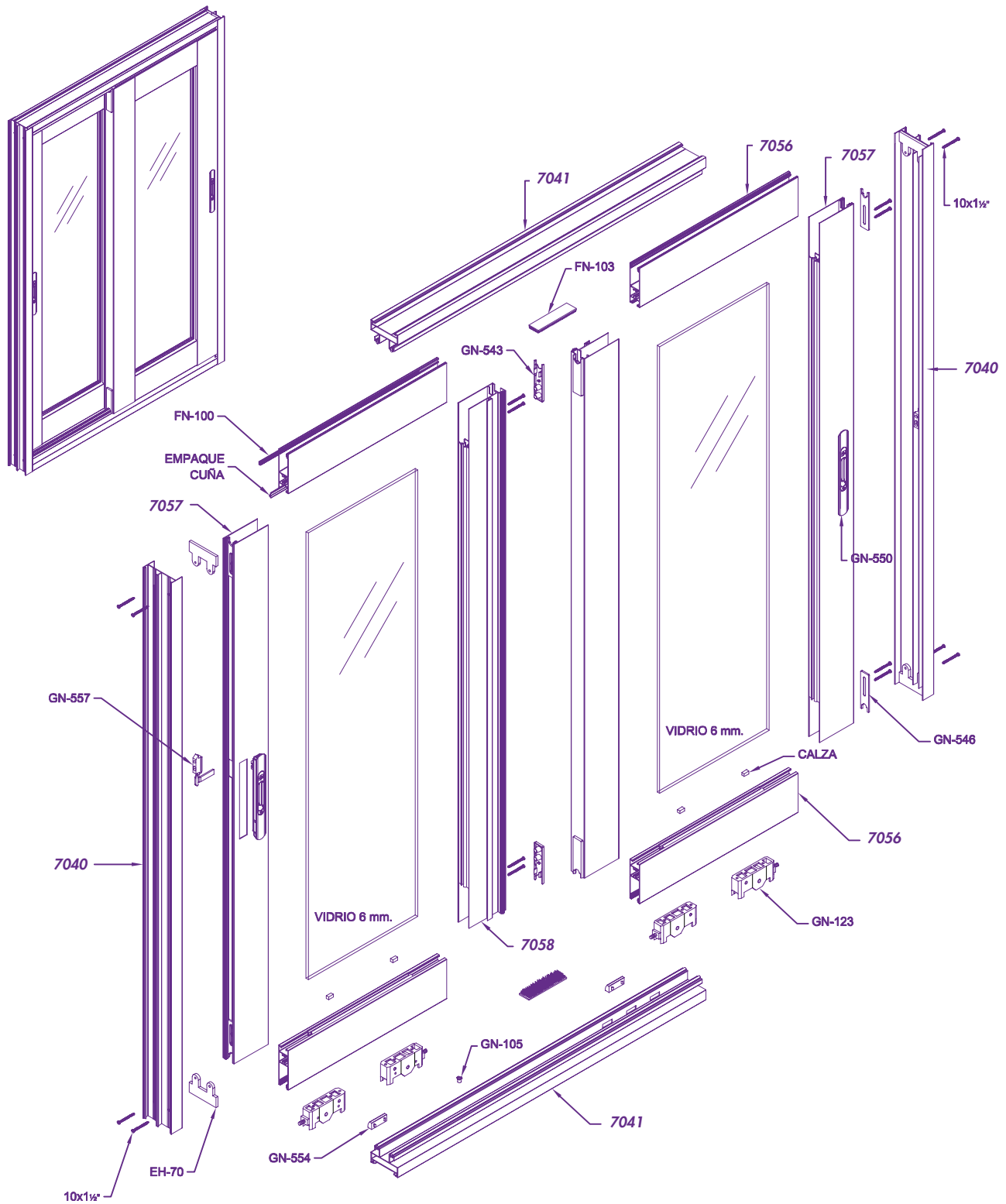
TABLA DE DESCUENTOS PUERTA

CLAVE	CLAVE	DESCRIPCIÓN	No. DE PIEZAS	CORTE Y DESCUENTO
7041	78407	RIEL-CABEZAL	2	L-26
7040	78408	JAMBA	2	H
7057	18409	CERCO	2	H-66
7056	12263	CABEZAL-ZOCLO	4	L/2 +9
7058	78410	TRASLAPE	2	H-66
	VIDRIO	L	2	L/2-126
		H		H-223
L = ANCHO DE CANCEL H = ALTO DE CANCEL				DESCUENTOS (MM.)



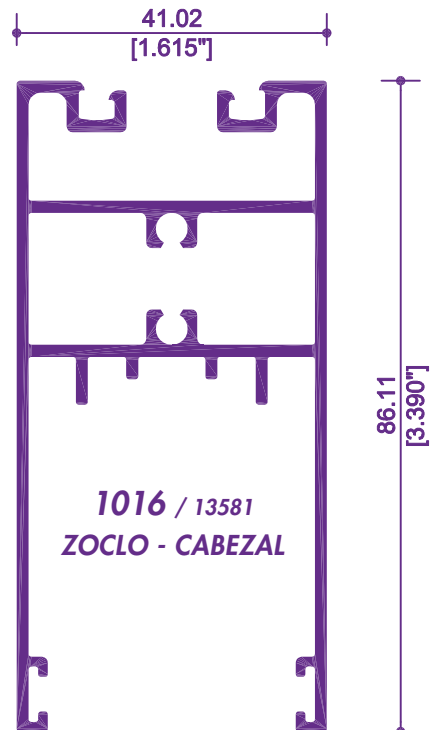
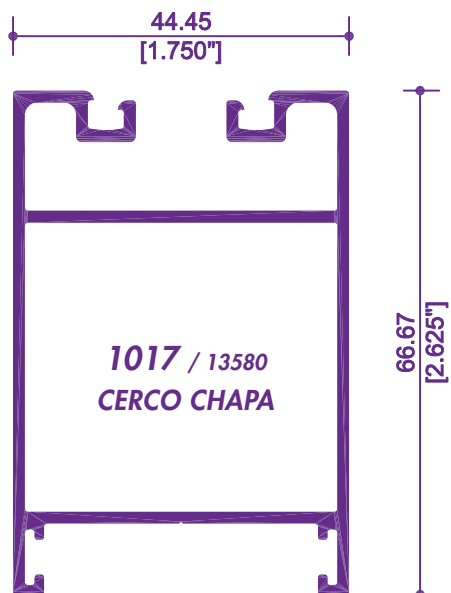
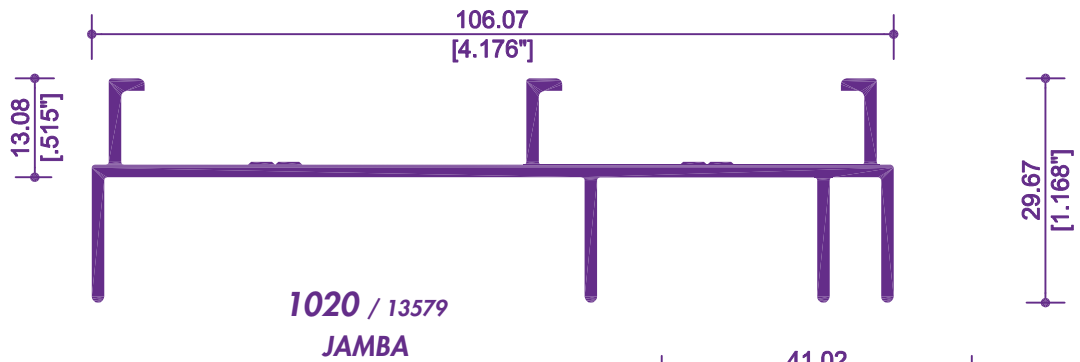
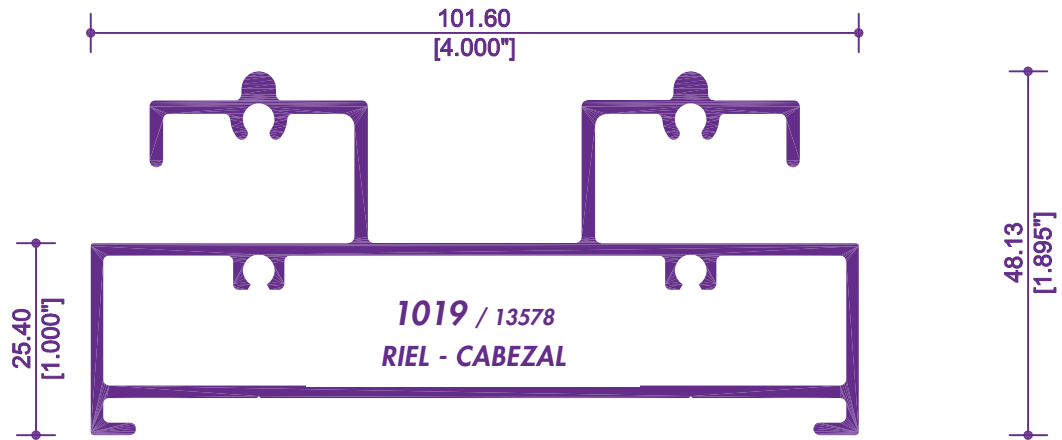

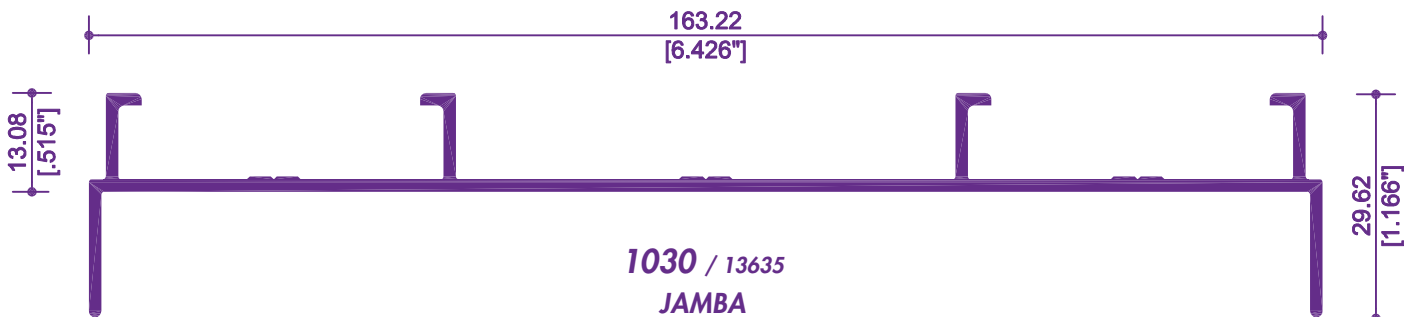
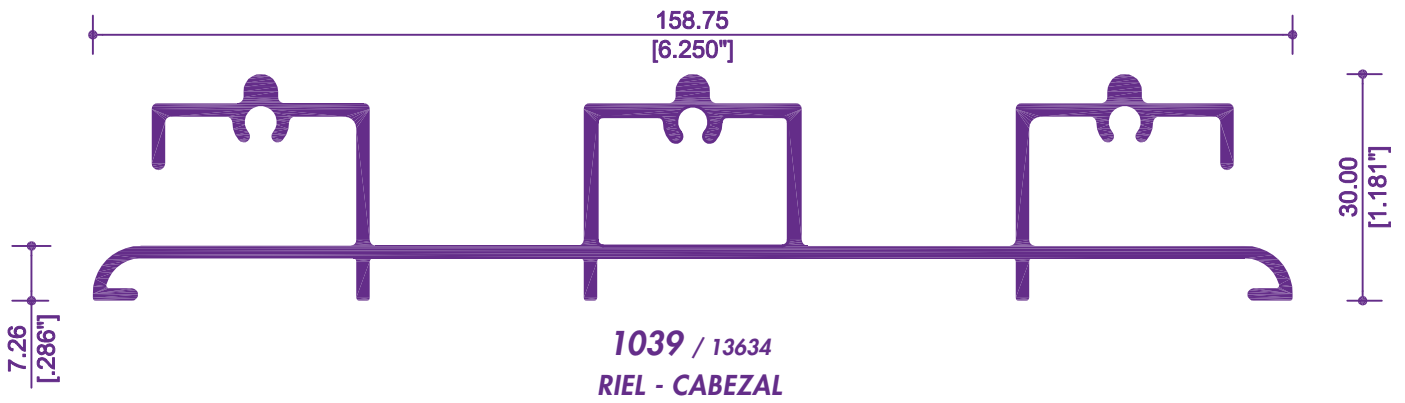
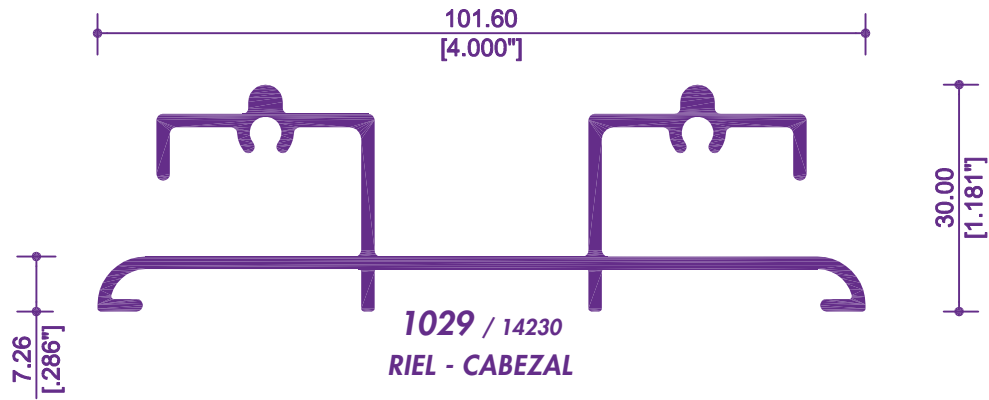

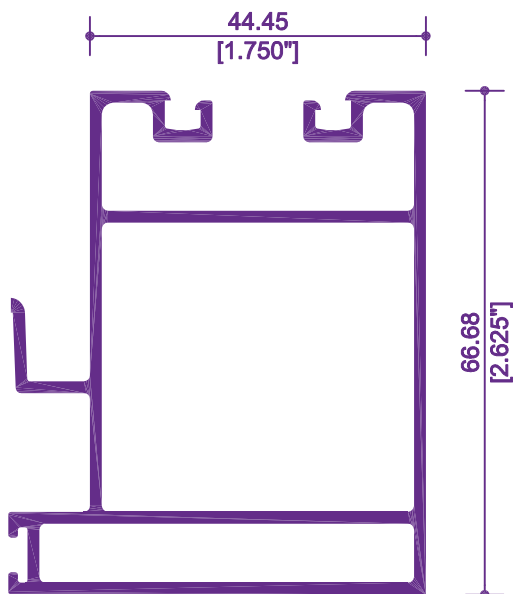

1018 / 14427
CERCO TRASLAPE

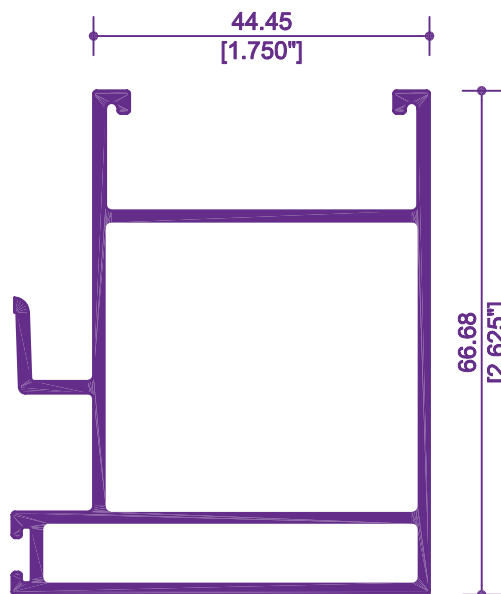

1028 / 18792
**CERCO TRASLAPE
DOBLE VIDRIO**

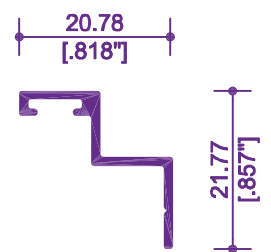

5043 / 50701
**ADAPTADOR
OXXO**



1031 / 13636
CANAL

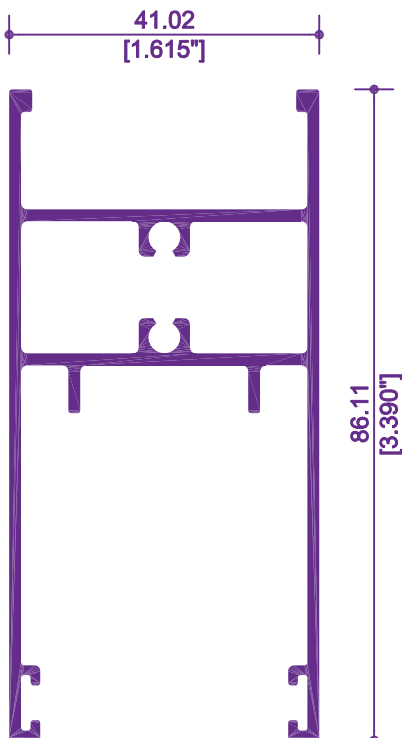

1026 / 14082
**ZOCLO - CABEZAL
DOBLE VIDRIO 1"**

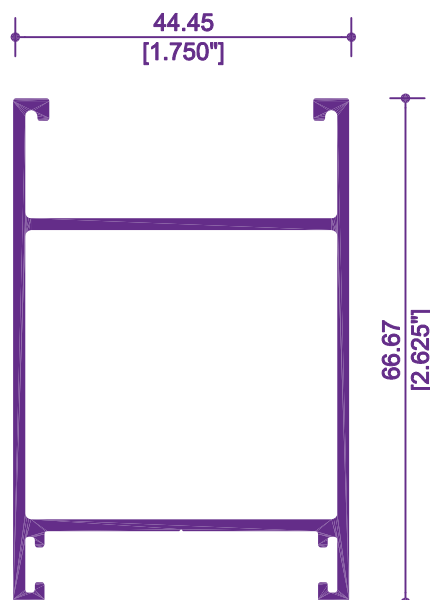

1027 / 14083
**CERCO CHAPA
DOBLE VIDRIO 1"**

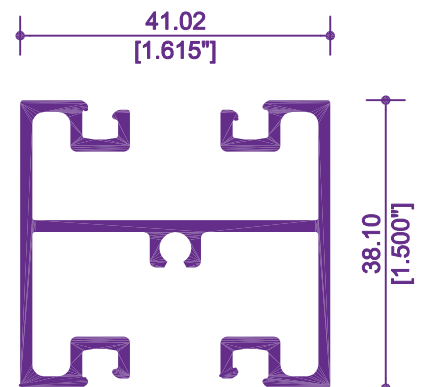

1021 / 14409
INTERMEDIO



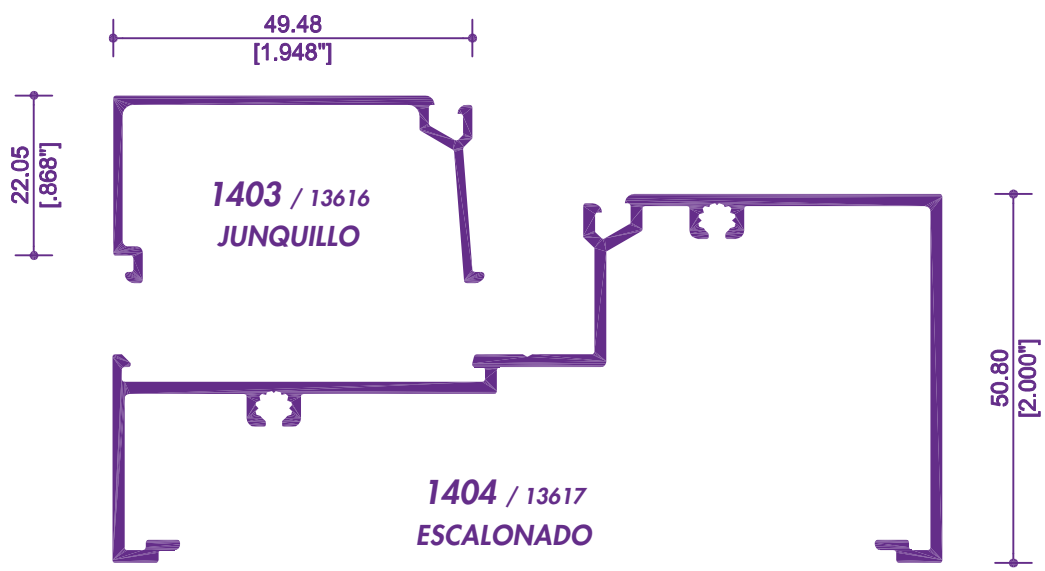
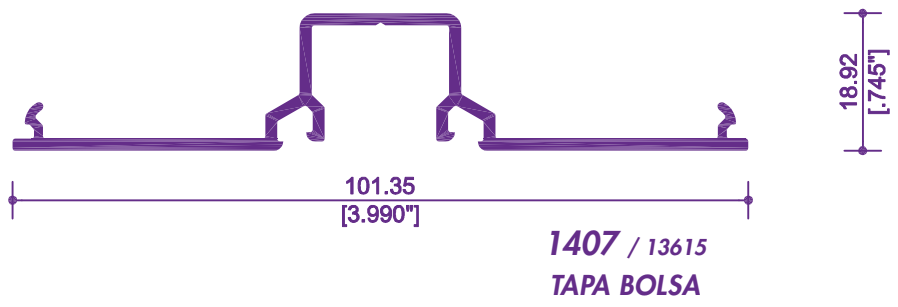
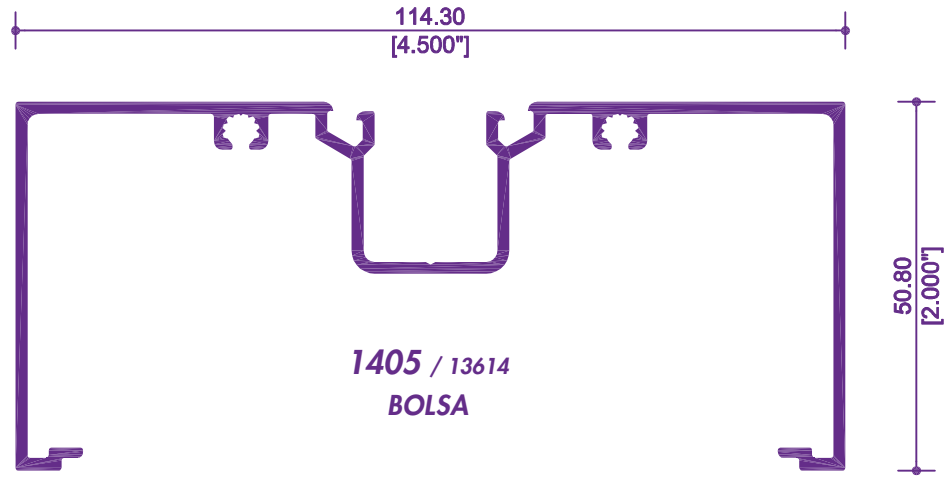

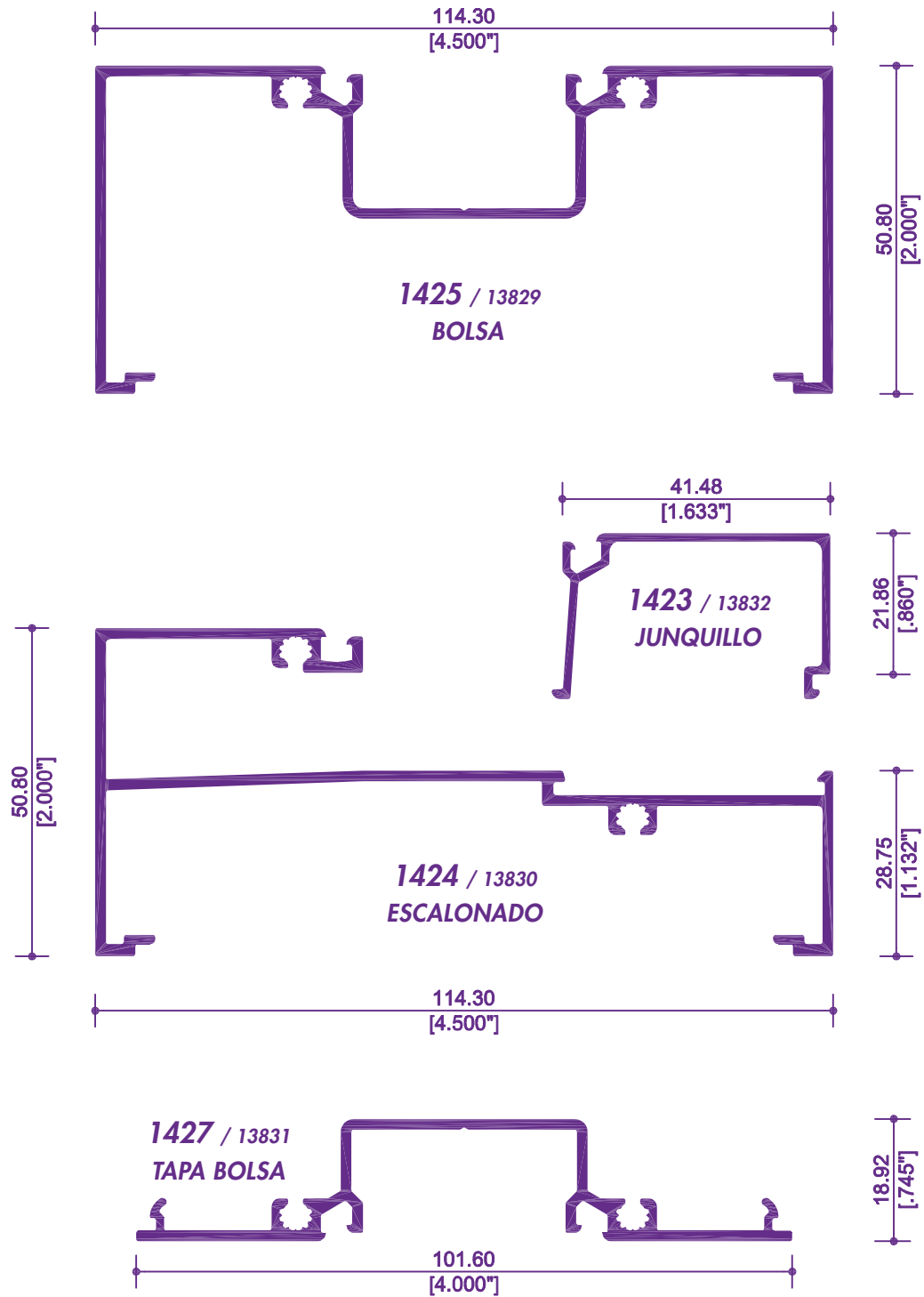

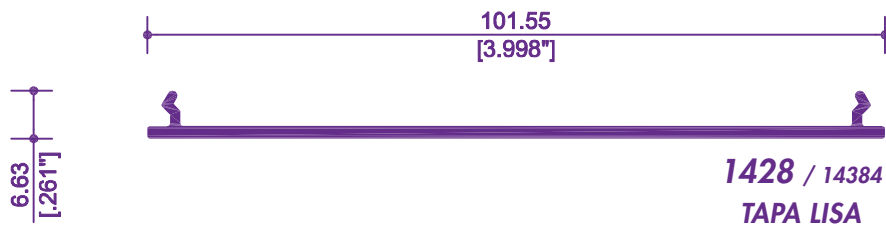
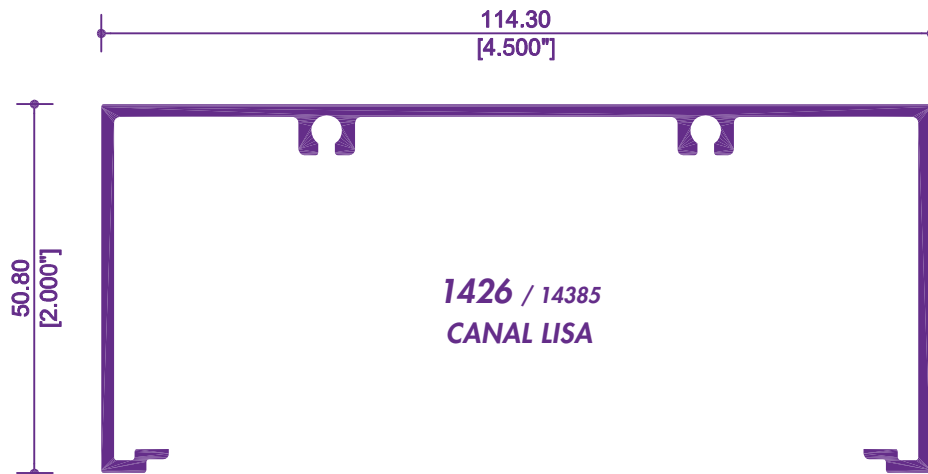
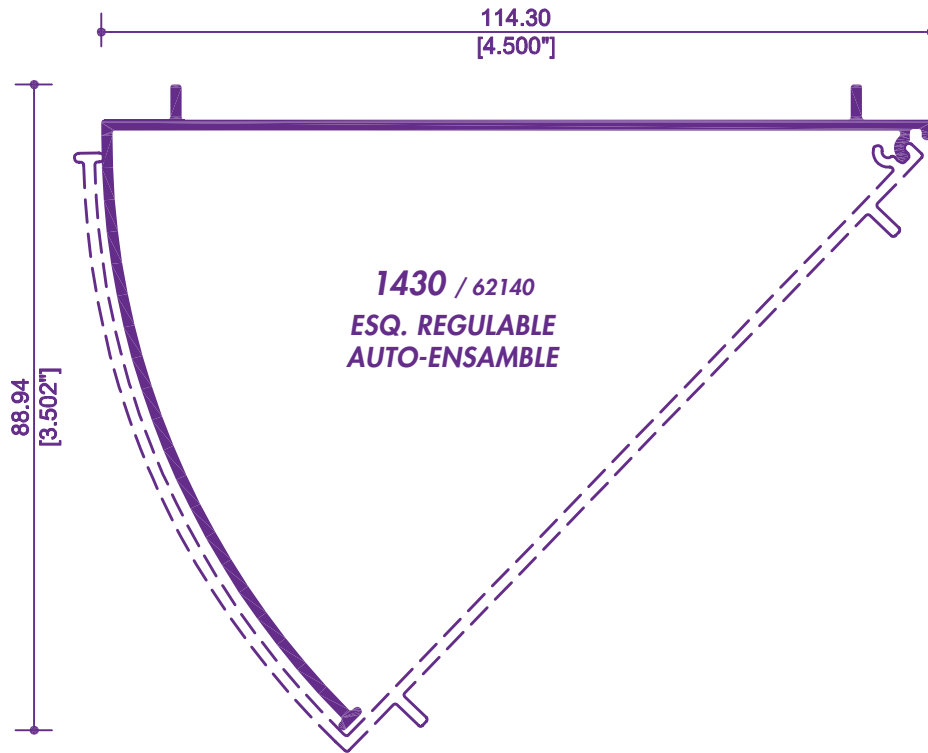

63.50
[2.500"]



4504 / 14349
TAPA PARA BÁSICO

9.53
[.375"]

63.50
[2.500"]



4506 / 14350
MOLDURA DE UNIÓN

14.16
[.558"]

63.50
[2.500"]



4500 / 14351
BÁSICO

100.14
[3.943"]

63.50
[2.500"]



4501 / 14389
BÁSICO

79.67
[3.137"]



alucentro

MURO CORTINA SERIE MC 450
PRODUCCIÓN

EUROVENT[®]
CLASSIC

63.50
[2.500"]

63.50
[2.500"]



112.06
[4.412"]



95.64
[3.766"]

152.40
[6.000"]



63.50
[2.500"]



63.50
[2.500"]

63.50
[2.500"]



4505 / 14698
BÁSICO

160.17
[6.306"]



4507 / 14739
BÁSICO

153.03
[6.025"]



alucentro

MURO CORTINA SERIE MC 450 PRODUCCIÓN

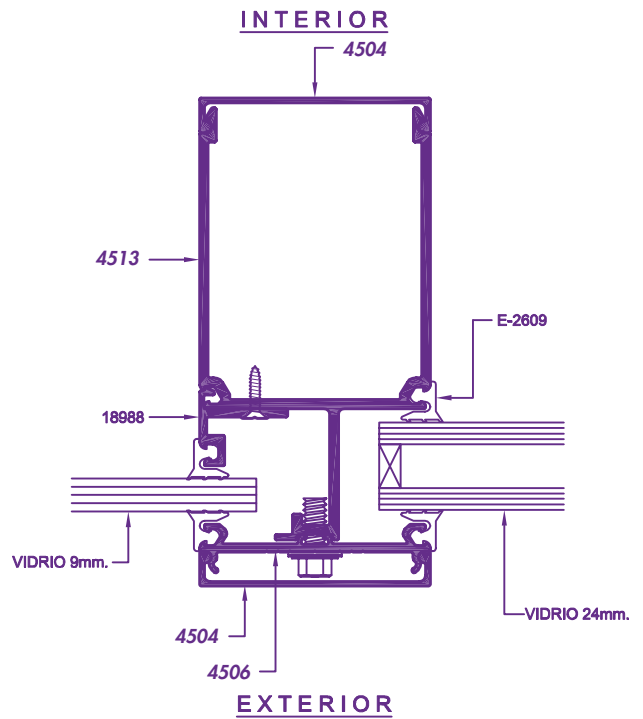
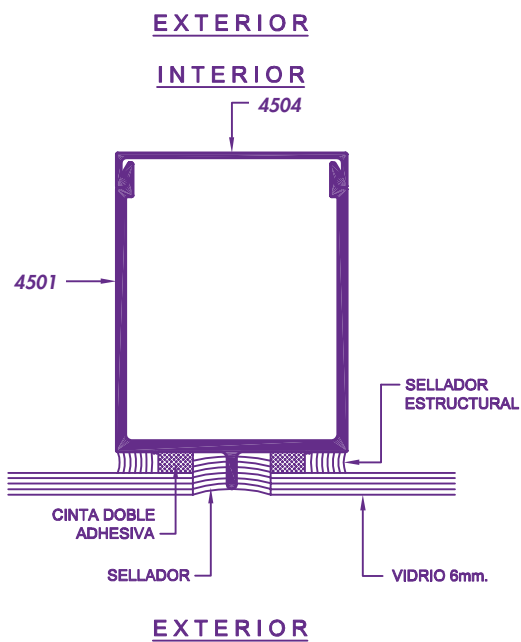
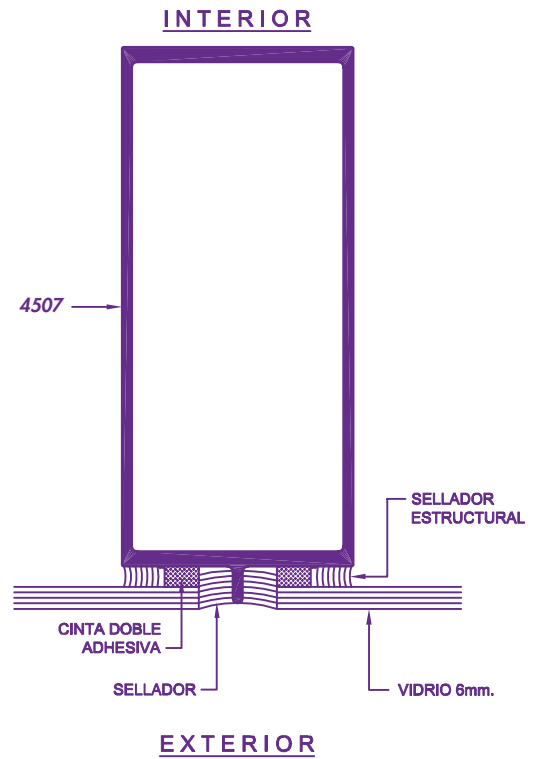
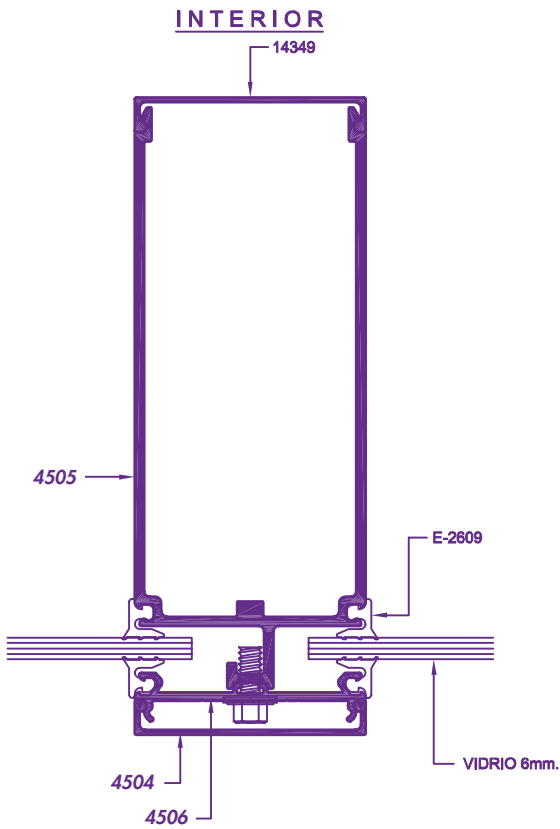

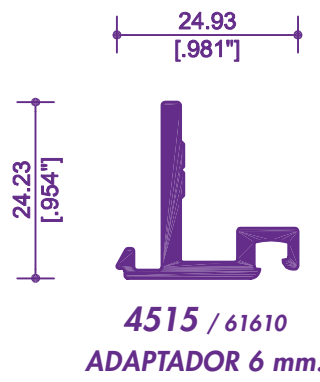
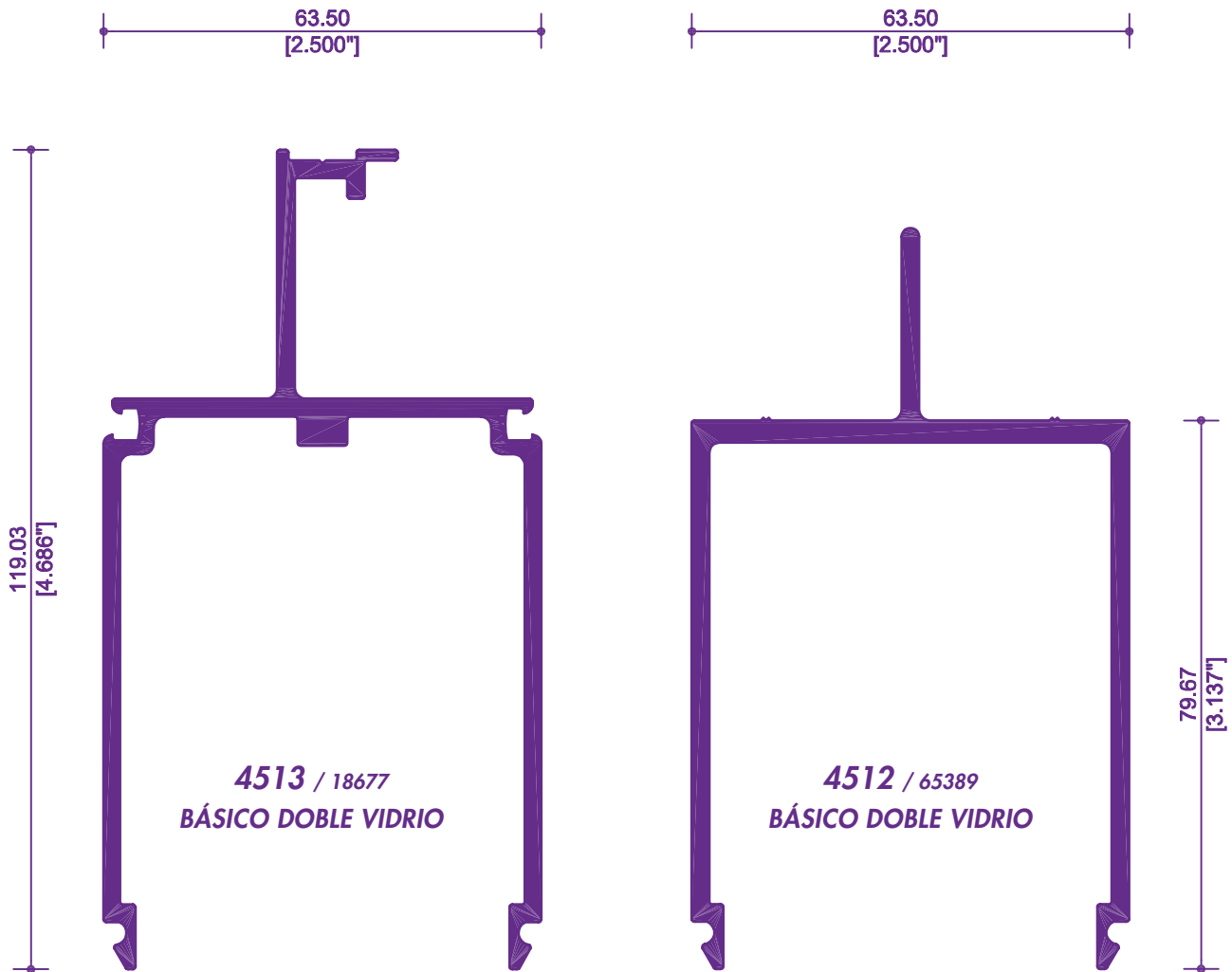

**MURO CORTINA SERIE MC 450
DOBLE VIDRIO - PRODUCCIÓN**

EUROVENT
CLASSIC

63.50
[2.500"]

63.50
[2.500"]



4516 / 61427
BÁSICO DOBLE VIDRIO

179.35
[7.061"]



4517 / 61428
BÁSICO DOBLE VIDRIO

182.01
[7.166"]



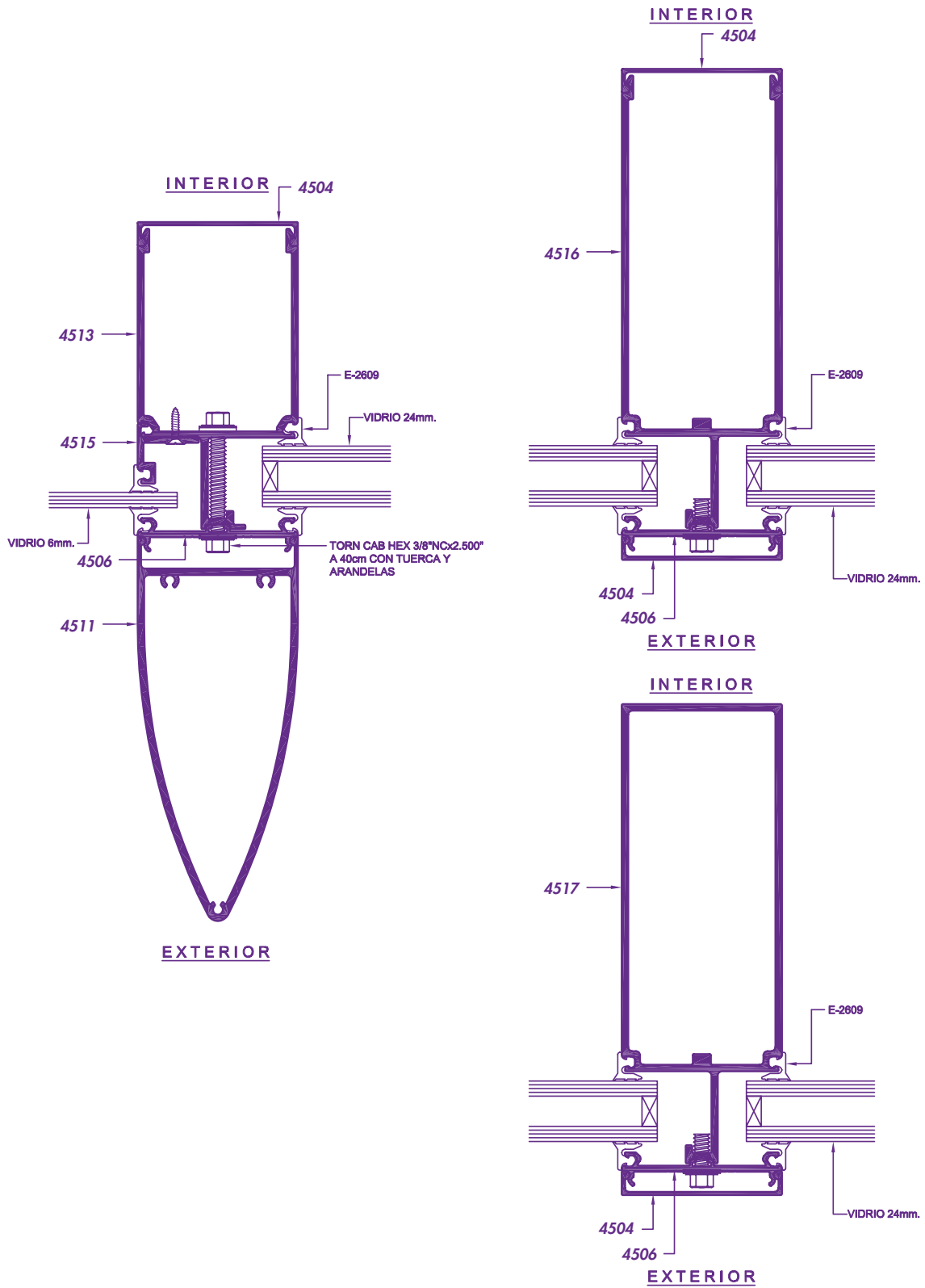

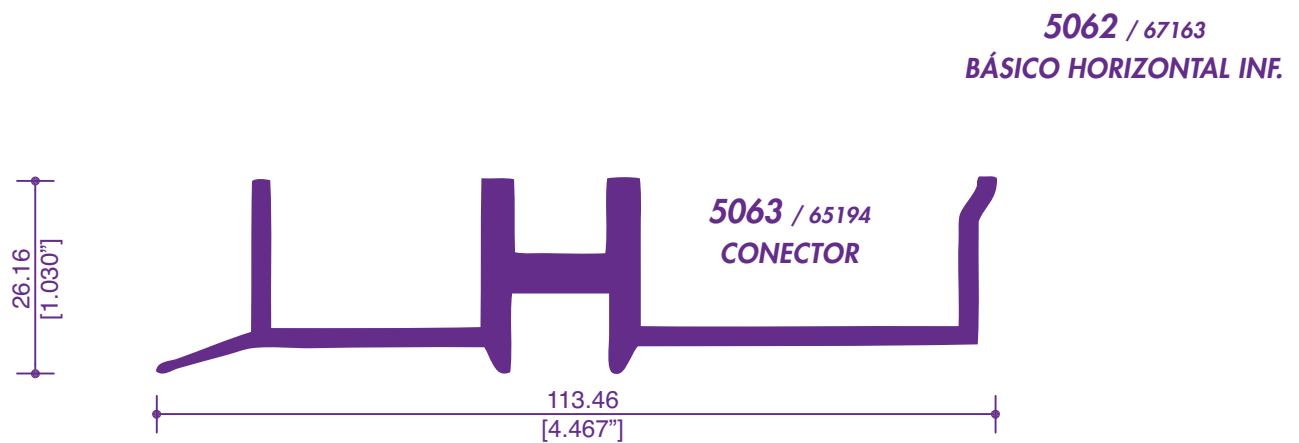
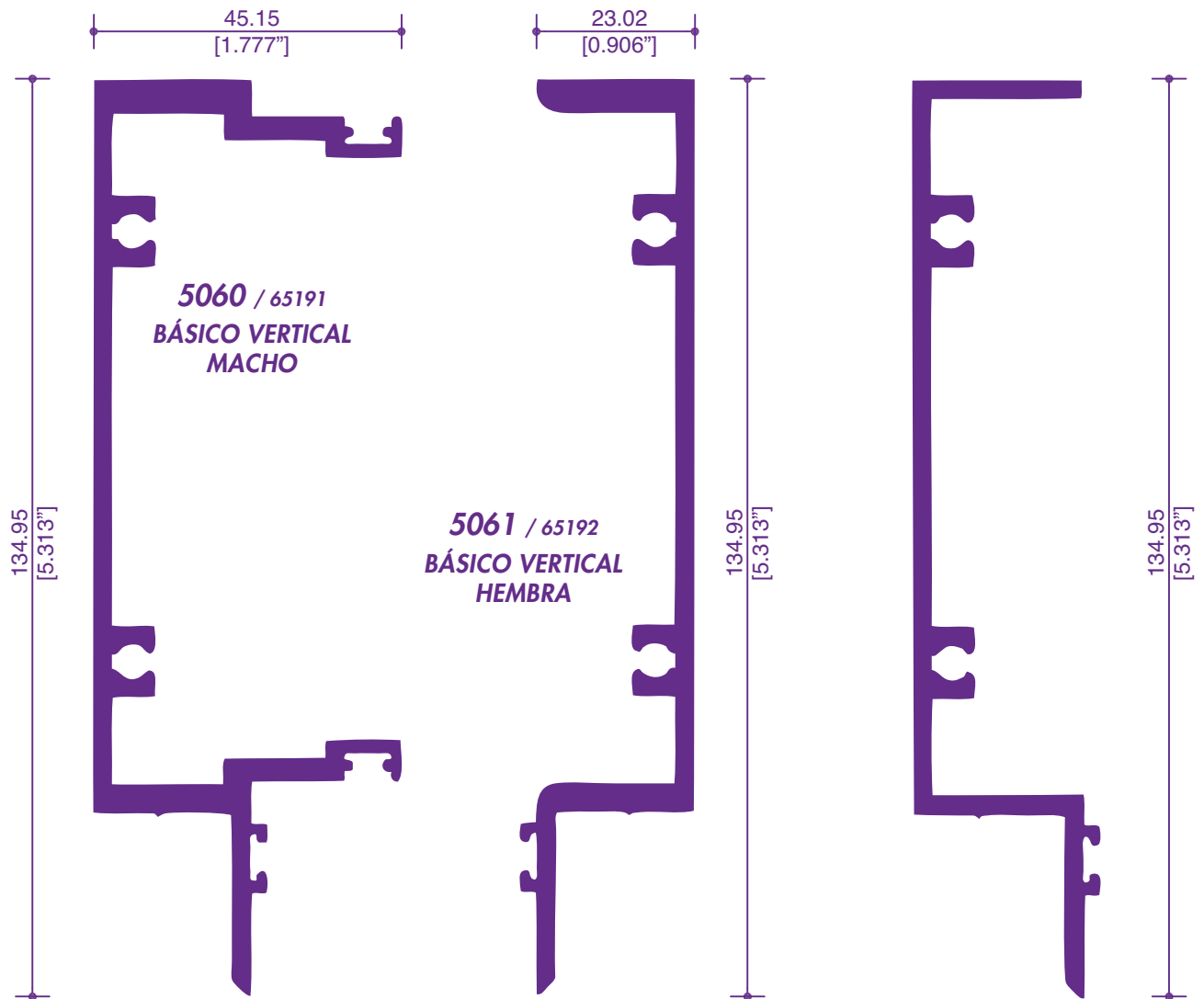

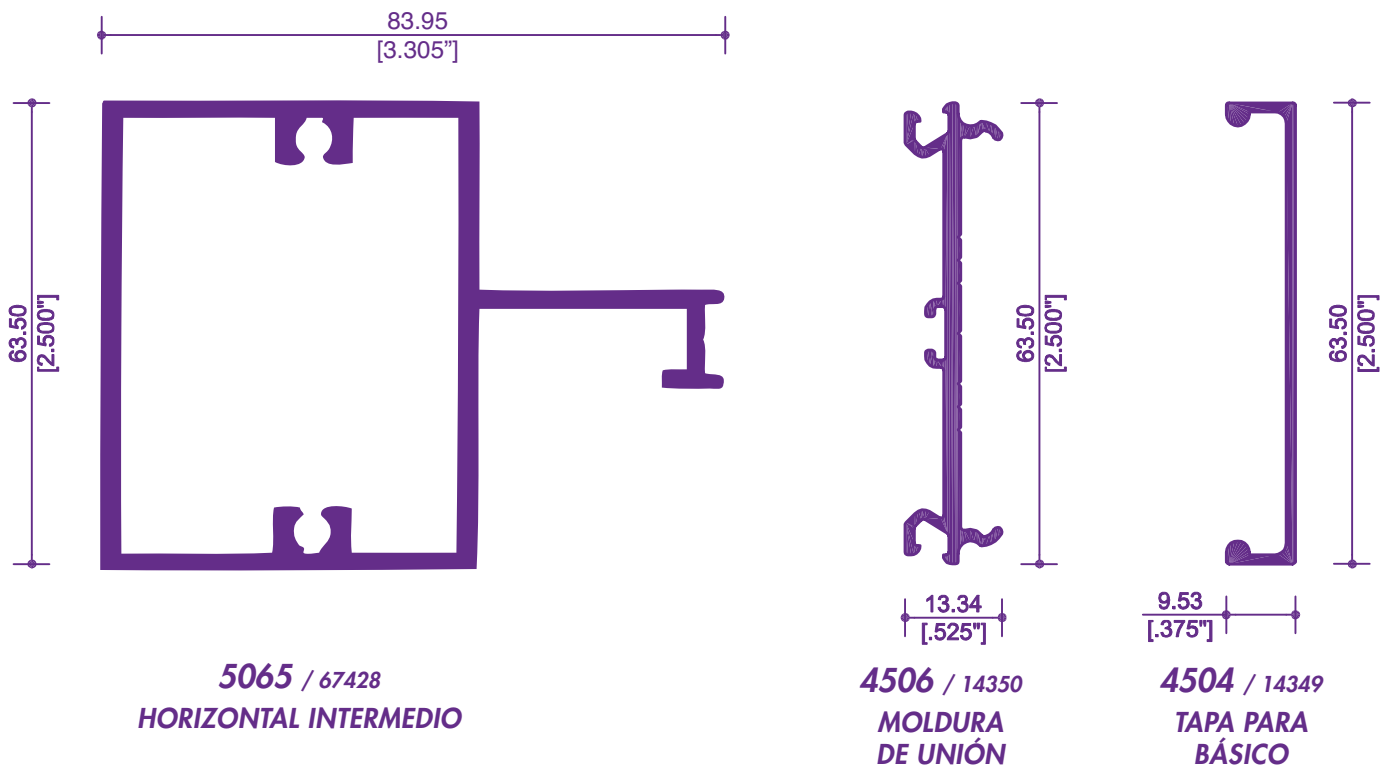
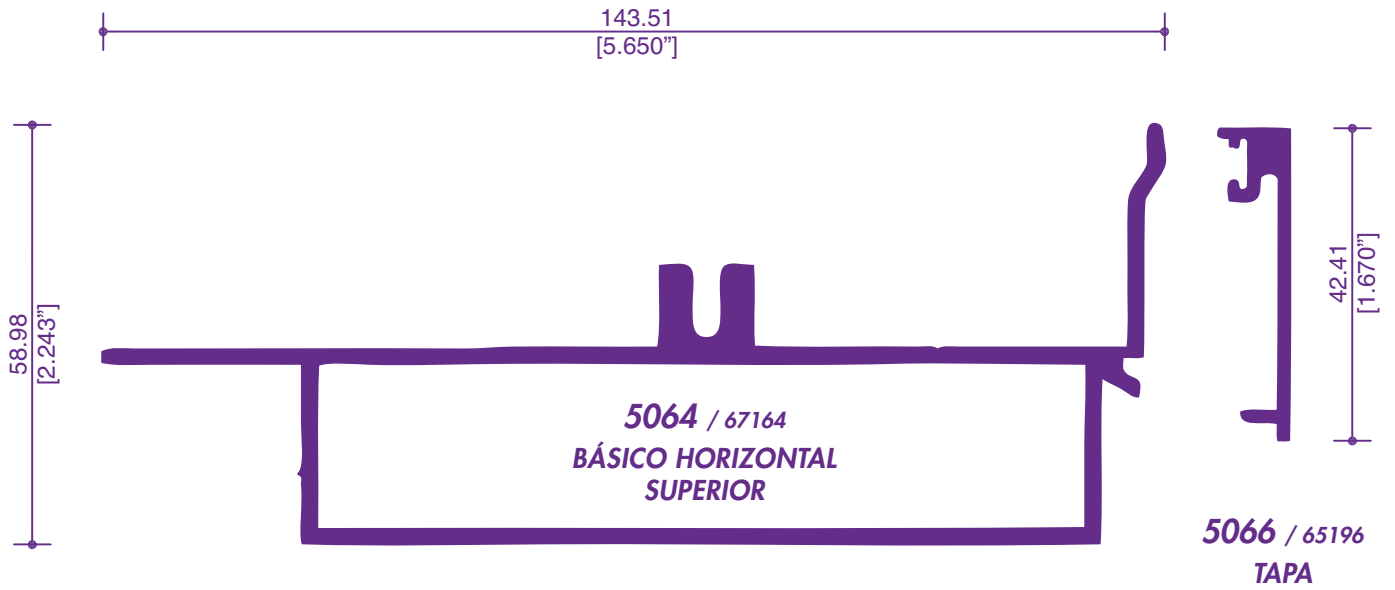

109.20
[4.299"]

5068 / 67430
VERTICAL ESQUINERO 90° DER.

109.88
[4.326"]

5067 / 67429
VERTICAL ESQUINERO 90° IZQ.



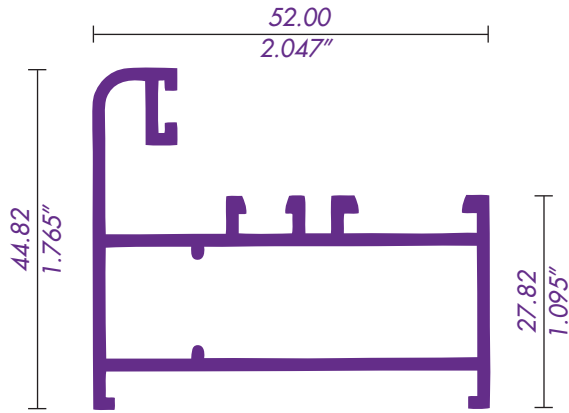

4525 / 62033
"L" CONTRAMARCO

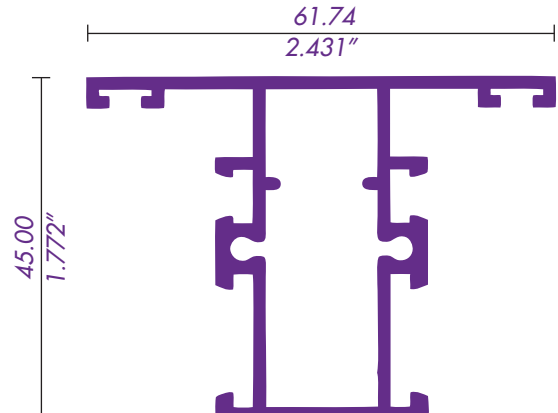

4521 / 62041
INTERMEDIO CUADRÍCULA

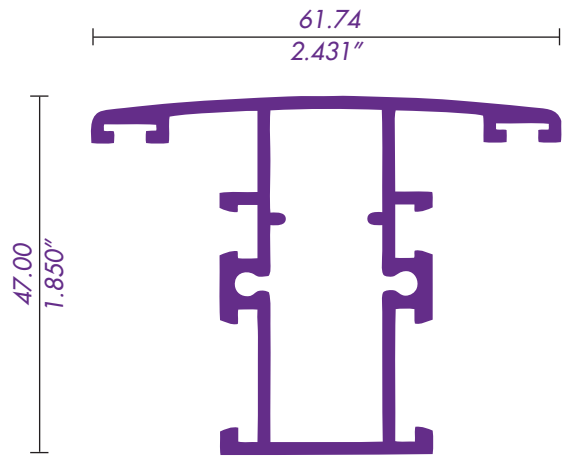

4524 / 62028
"T" INTERMEDIO

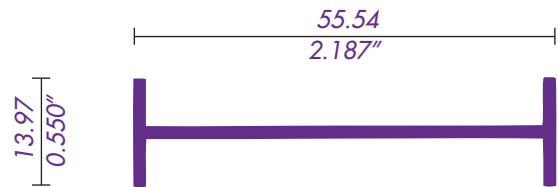

4539 / 62042
MOLDURA DE UNIÓN

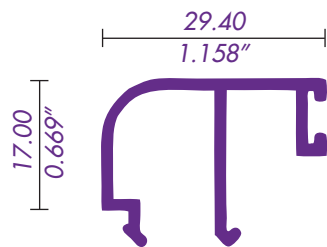

4594 / 62029
JUNQUILLO 6mm.

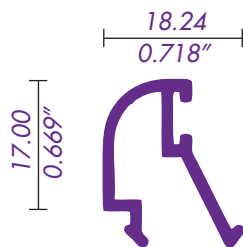

4593 / 62030
JUNQUILLO 24mm.

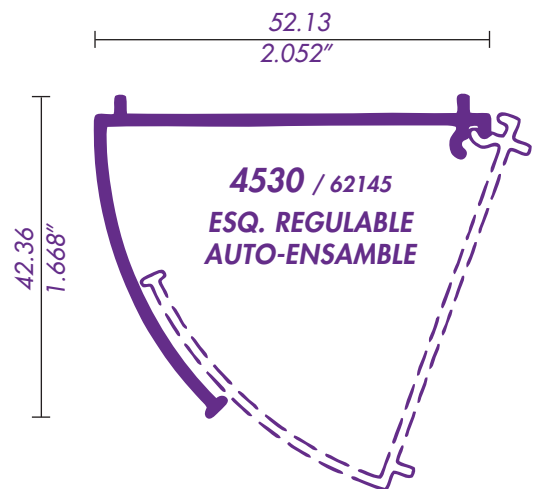

4530 / 62145
ESQ. REGULABLE
AUTO-ENSAMBLE





TABLA DE DESCUENTOS FIJO DE UN CLARO			
CLAVE	DESCRIPCIÓN	No. DE PIEZAS	CORTE Y DESCUENTO
4525	CONTRAMARCO	2	L
4525	CONTRAMARCO	2	H
4594	JUNQUILLO	2	L-46
4594	JUNQUILLO	2	H-46
VIDRIO	L	1	L-64
	H		H-64
L= ANCHO DE VENTANA H= ALTO DE VENTANA			DESCUENTOS EN MM.





4521 / 62041
INTERMEDIO CUADRÍCULA

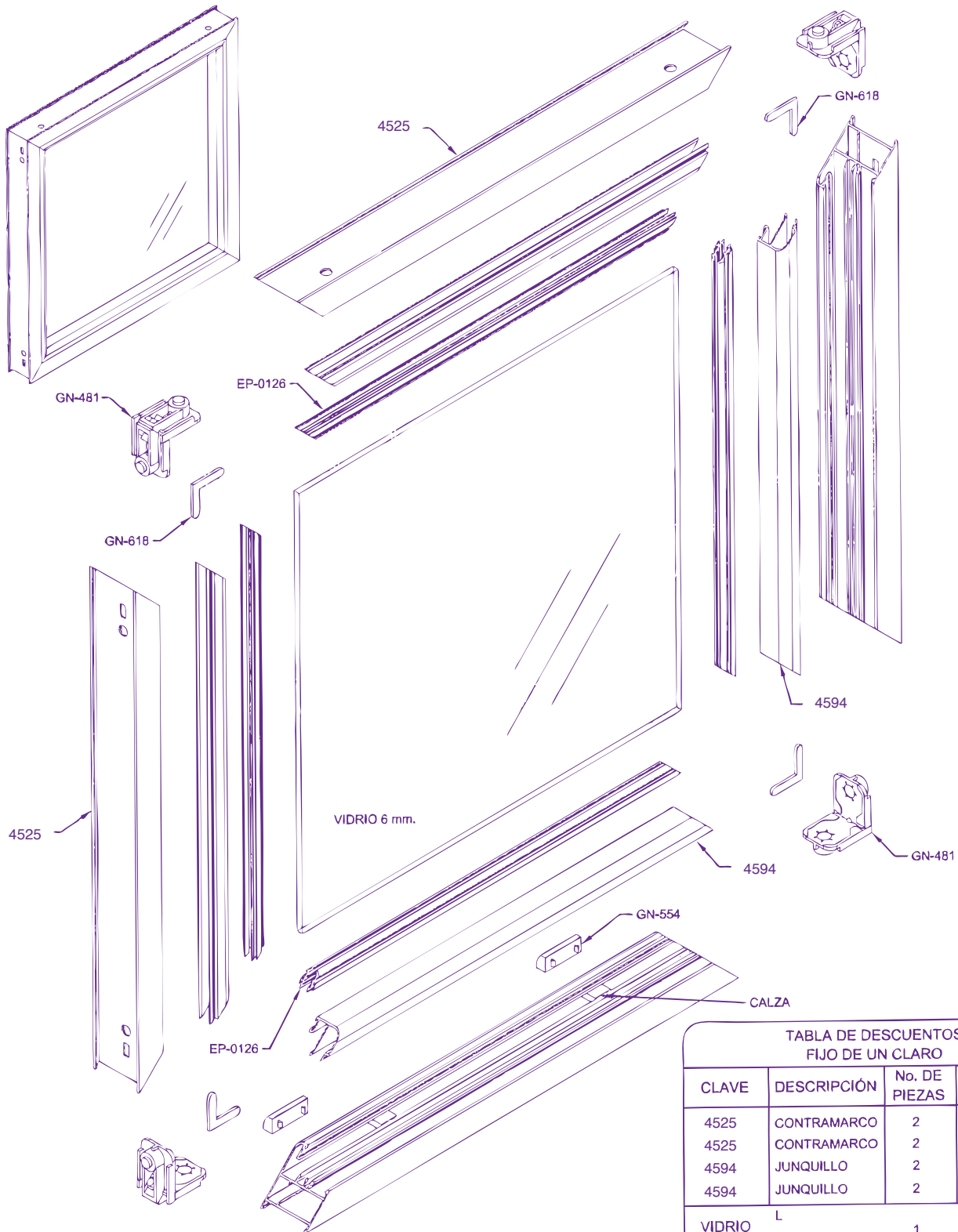
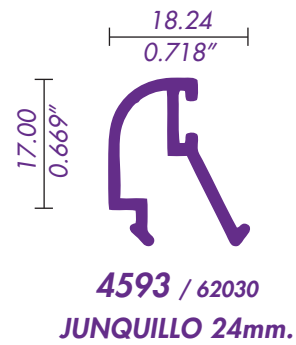
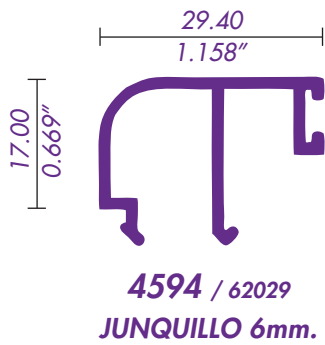
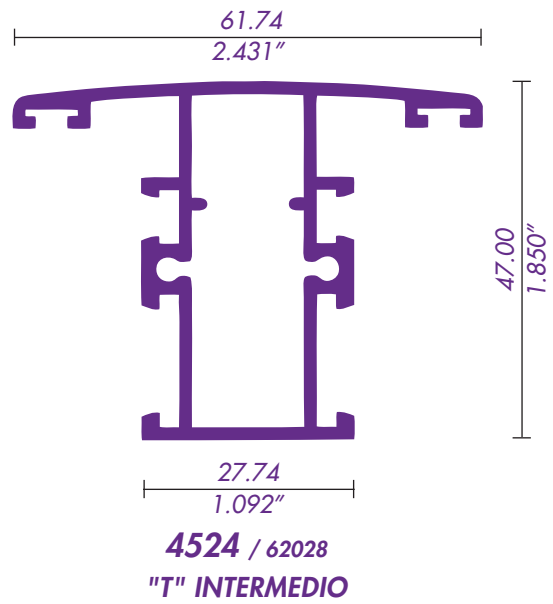
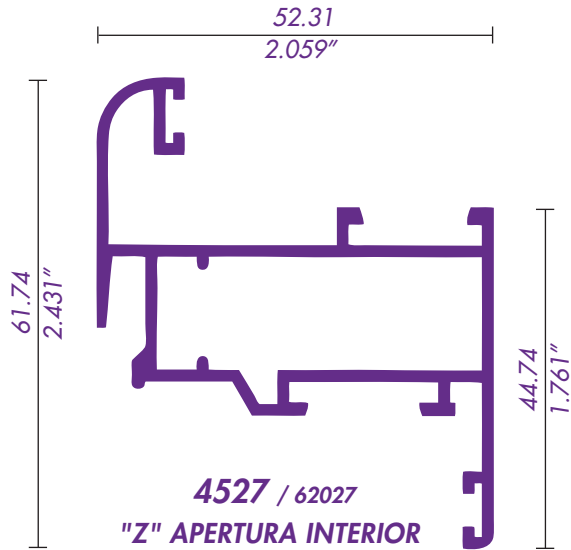
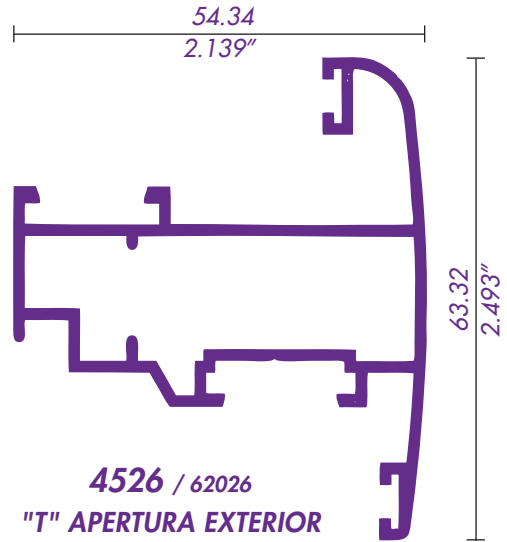
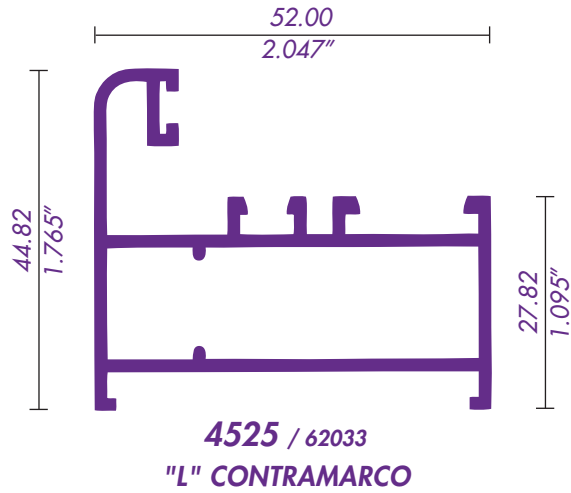
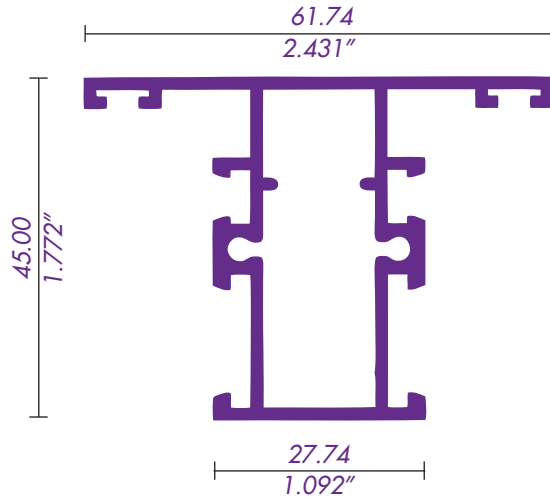
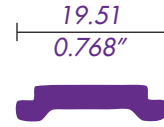

4529 / 45050
PLETINA

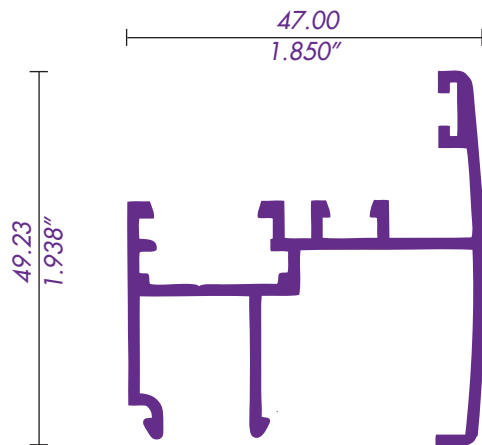

4528 / 62031
INTERMEDIO MÓVIL

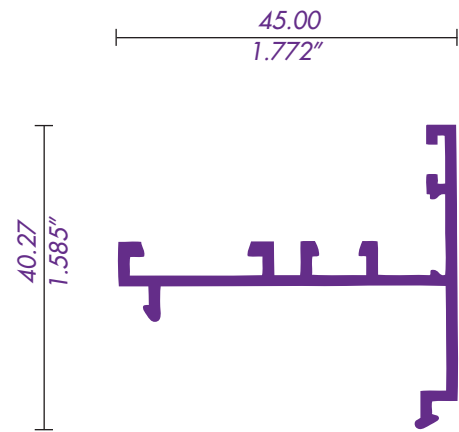

4522 / 62032
CONVERTIDOR



SECCIÓN 16

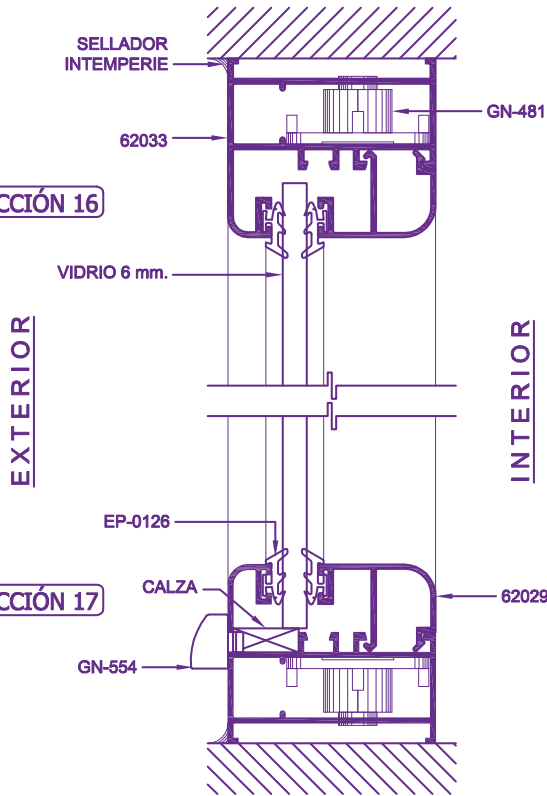

SECCIÓN 18

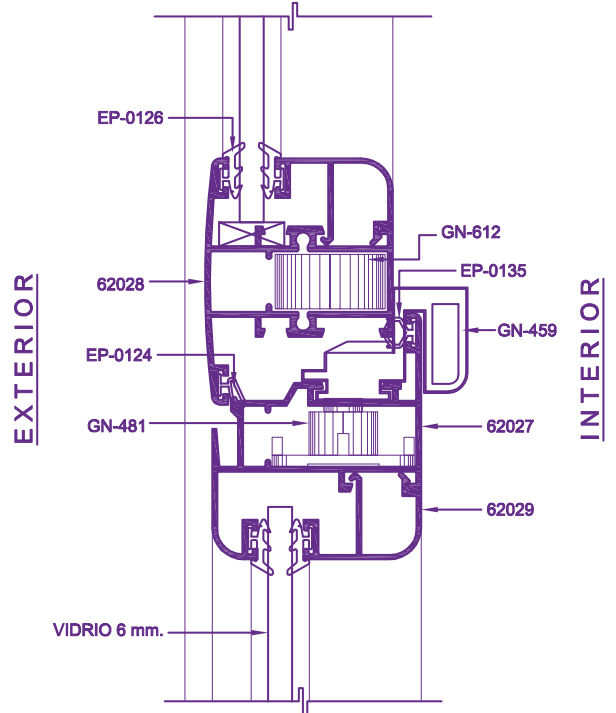

SECCIÓN 19

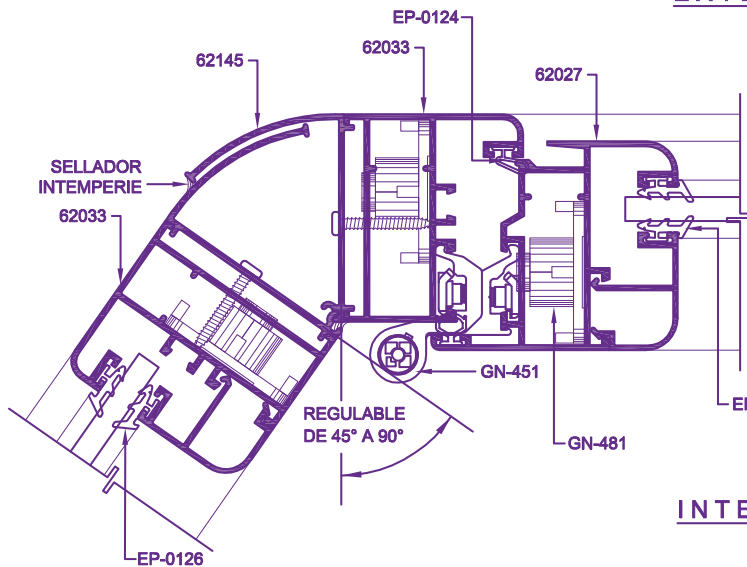

EXTERIOR

INTERIOR

SECCIÓN 20

OPCIÓN

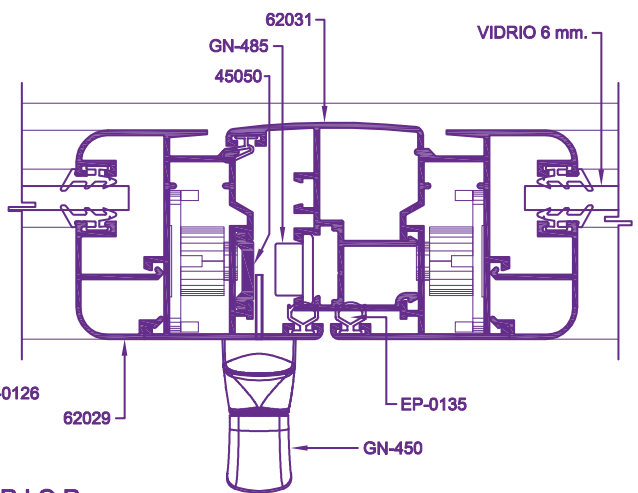

VENTANA SERIE 45 - ELEVACIONES APERTURA INTERIOR

EUROVENT
PREMIUM



TABLA DE DESCUENTOS VENTANA INTERIOR			
CLAVE	DESCRIPCIÓN	No. DE PIEZAS	CORTE Y DESCUENTO
4525	CONTRAMARCO	2	L
4525	CONTRAMARCO	2	H
4527	"Z" APERTURA INTERIOR	2	L-45
4594	JUNQUILLO	2	L-128
4527	"Z" APERTURA INTERIOR	2	H-45
4594	JUNQUILLO	2	H-128
4529	PLETINA	2	H/2-160
VIDRIO	L	1	L-146
	H		H-146

L= ANCHO DE VENTANA
H= ALTO DE VENTANA

DESCUENTOS EN MM.



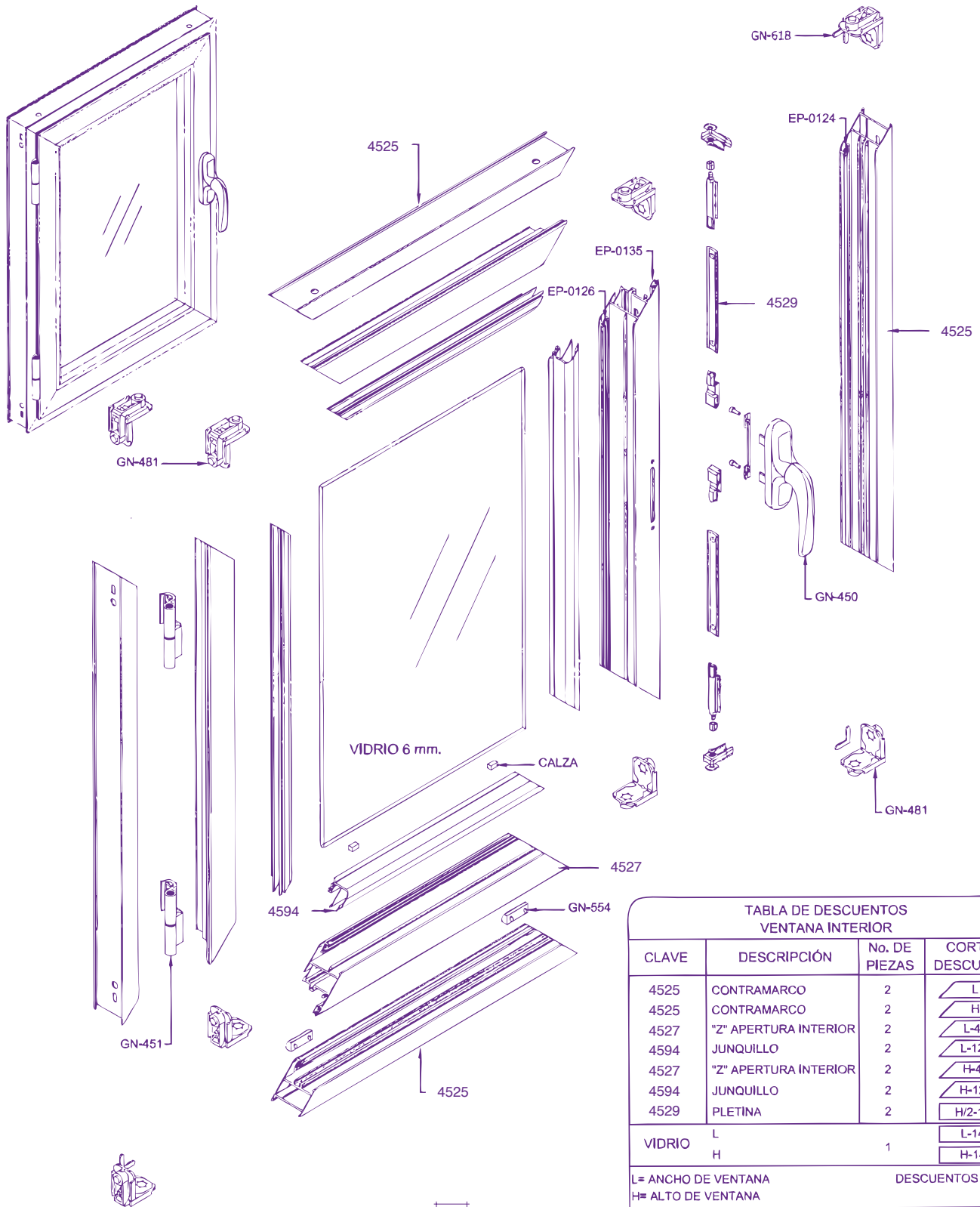
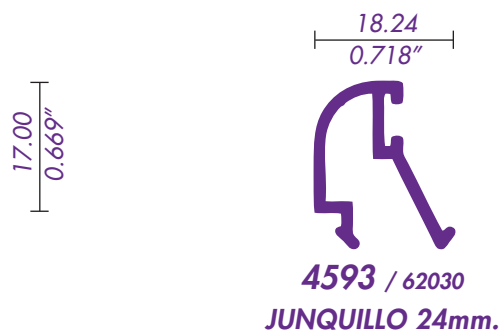
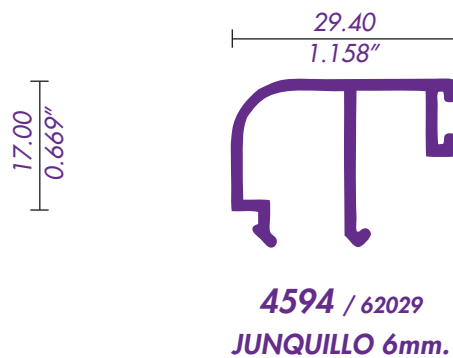
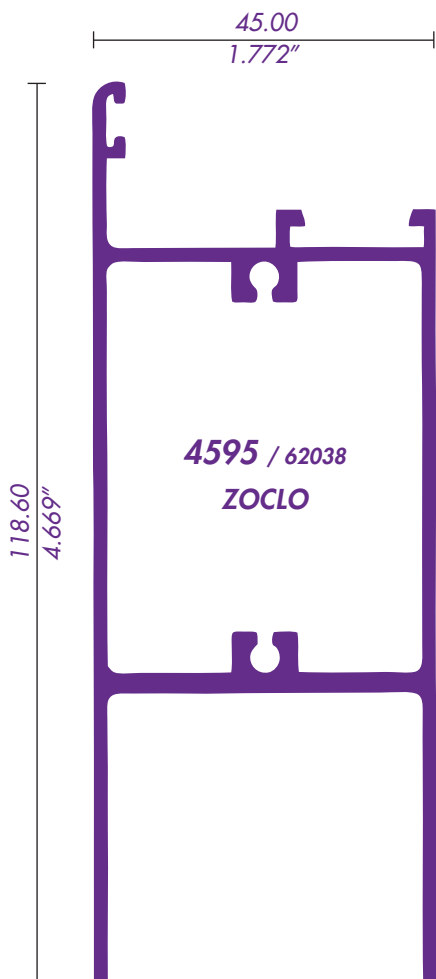
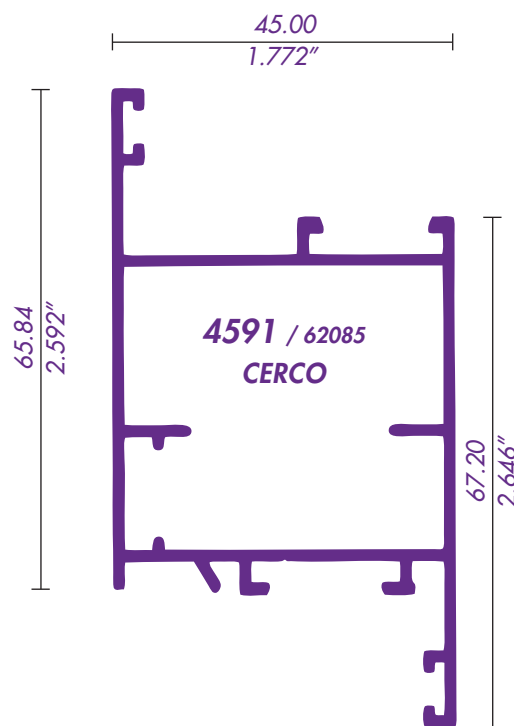
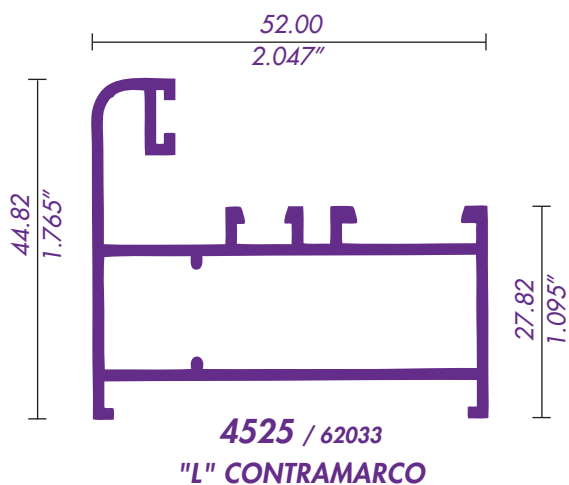

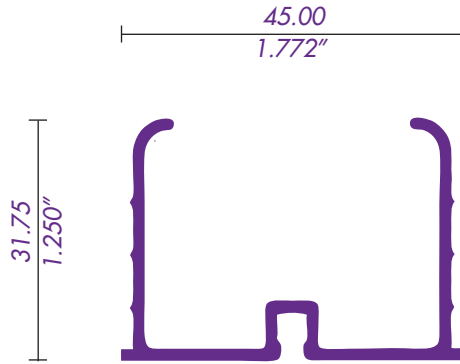

4587 / 62040
SELLO DE HERMETICIDAD

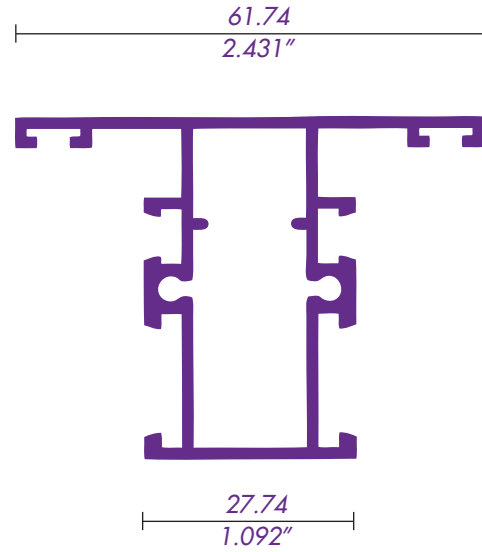

4521 / 62041
INTERMEDIO CUADRICULA

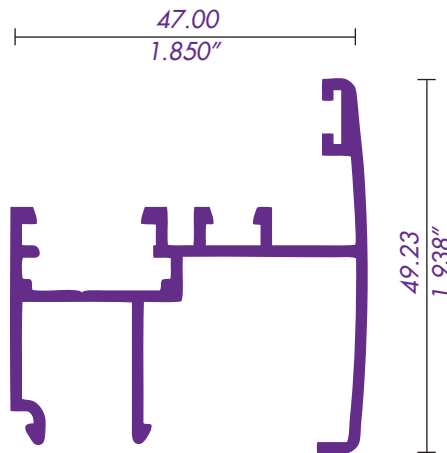

4528 / 62031
INTERMEDIO MOVIL



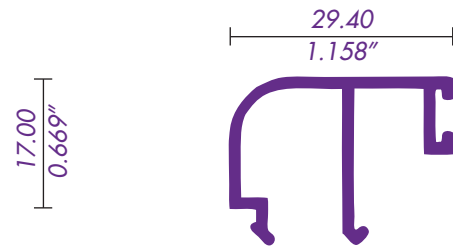
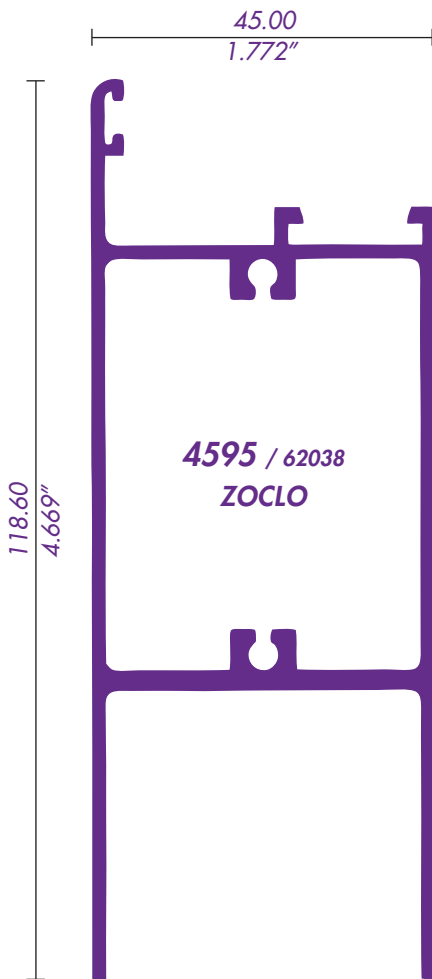
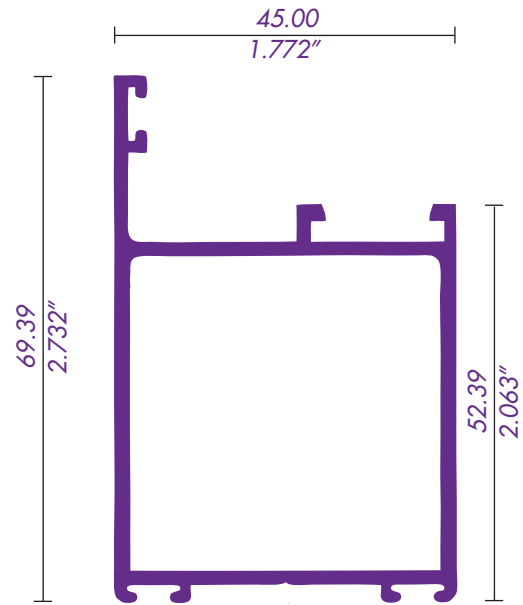
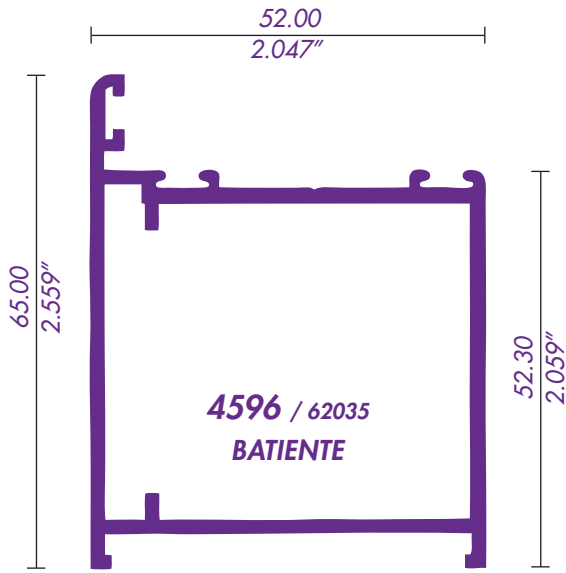

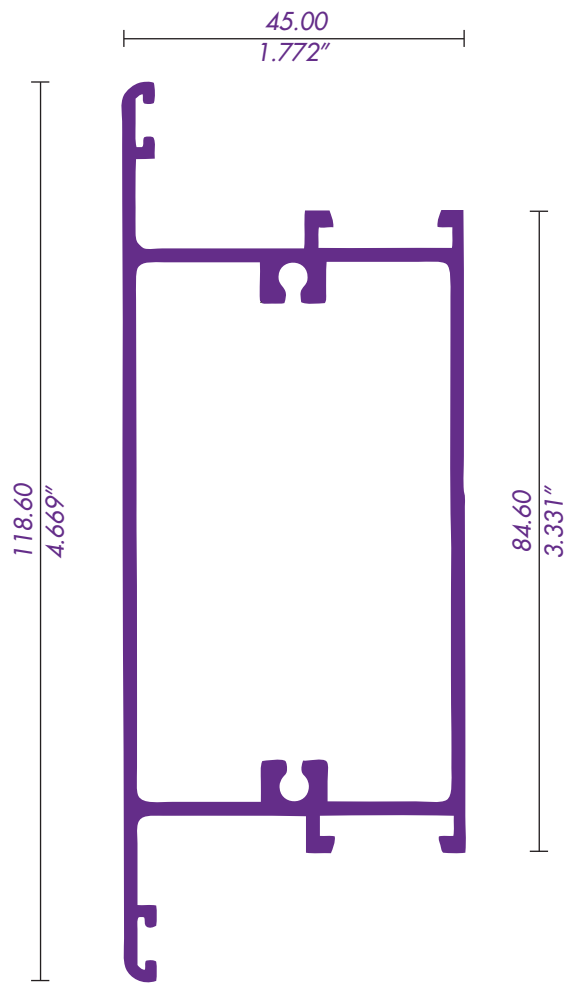

4592 / 62039
INTERMEDIO

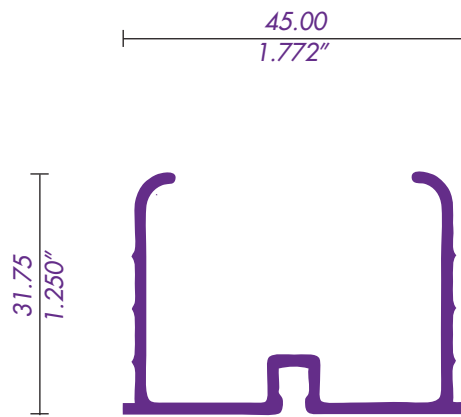

4587 / 62040
SELLO DE HERMETICIDAD

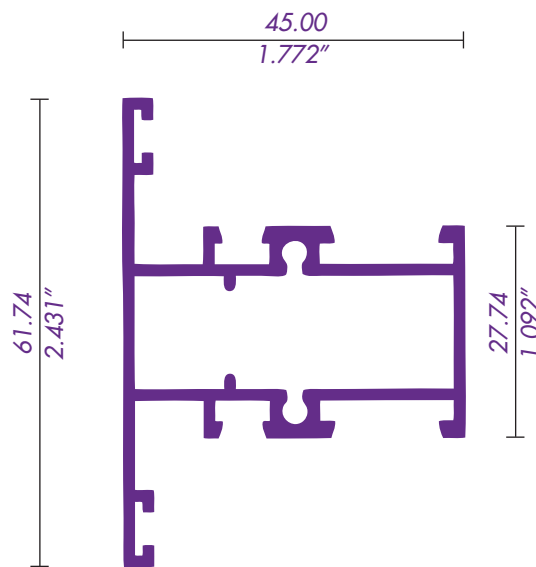

4521 / 62041
INTERMEDIO CUADRICULA



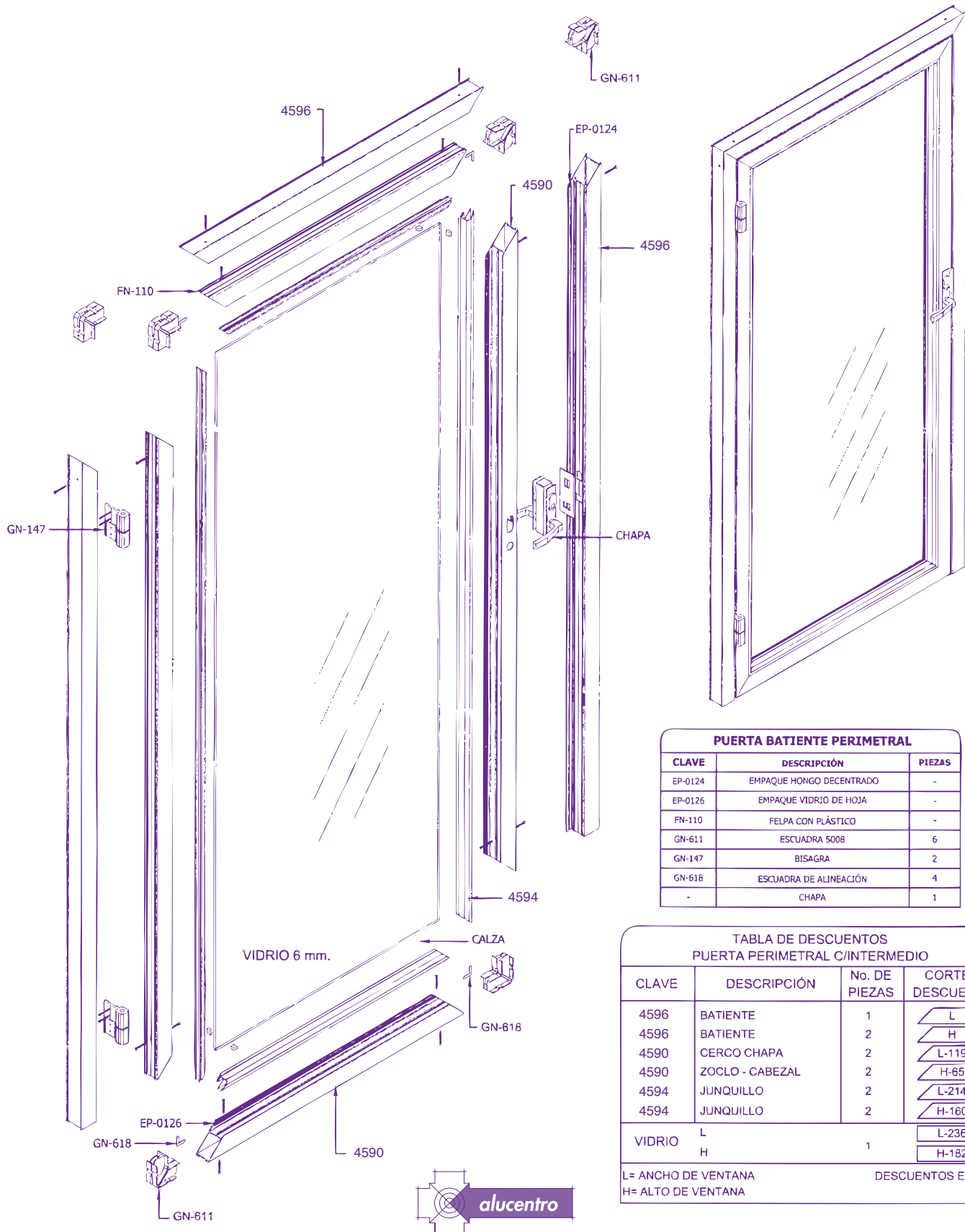

PUERTA BATIENTE PERIMETRAL

CLAVE	DESCRIPCIÓN	PIEZAS
EP-0124	EMPAQUE HONGO DECENTRADO	-
EP-0126	EMPAQUE VIDRIO DE HOJA	-
FN-110	FELPA CON PLÁSTICO	-
GN-611	ESCUADRA 5008	6
GN-147	BISAGRA	2
GN-618	ESCUADRA DE ALINEACIÓN	4
-	CHAPA	1

**TABLA DE DESCUENTOS
PUERTA PERIMETRAL C/INTERMEDIO**

CLAVE	DESCRIPCIÓN	No. DE PIEZAS	CORTE Y DESCUENTO
4596	BATIENTE	1	L
4596	BATIENTE	2	H
4590	CERCO CHAPA	2	L-119
4590	ZOCLO - CABEZAL	2	H-65
4594	JUNQUILLO	2	L-214
4594	JUNQUILLO	2	H-160
VIDRIO	L	1	L-236
	H		H-182

L= ANCHO DE VENTANA
H= ALTO DE VENTANA

DESCUENTOS EN MM.



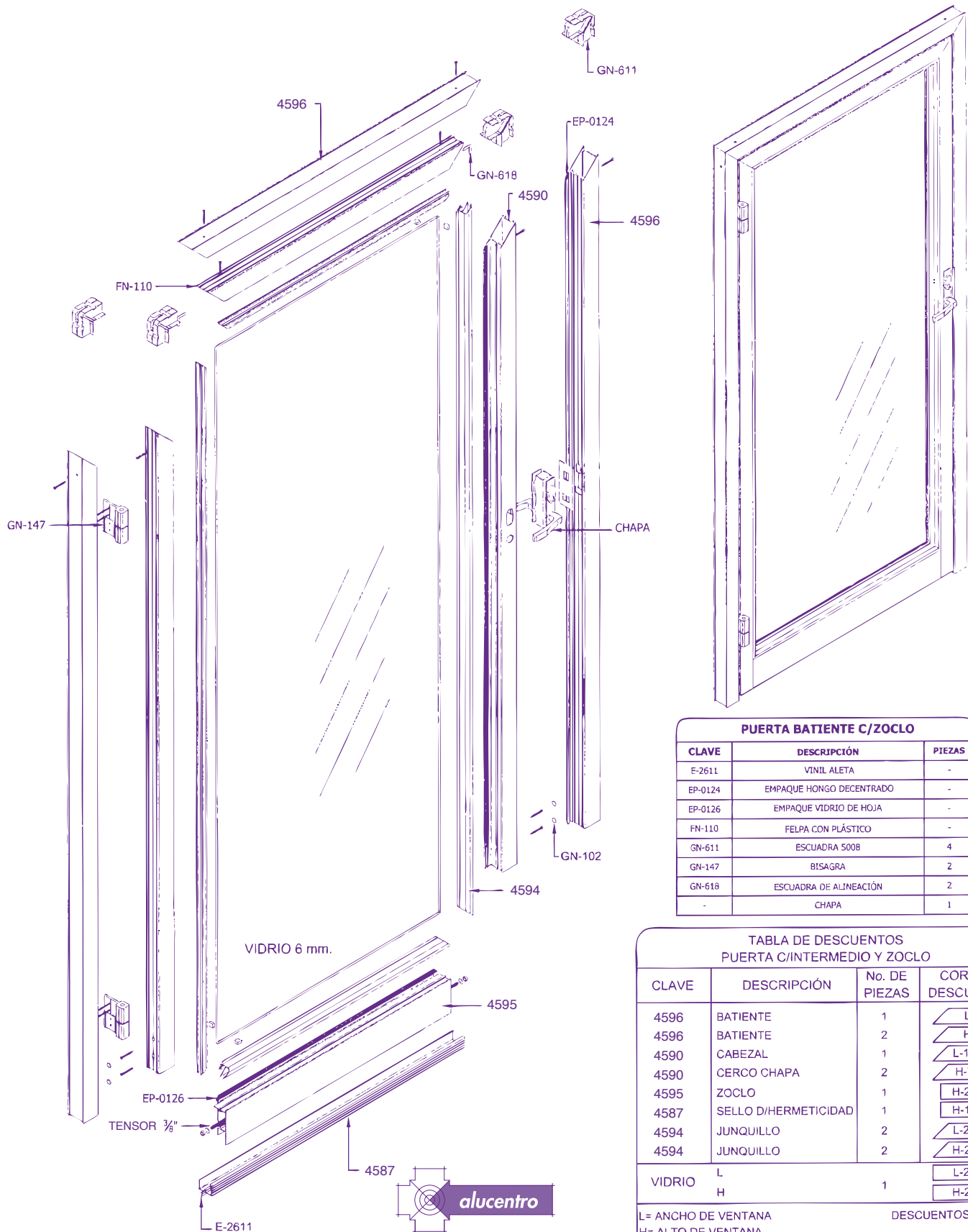

PUERTA BATIENTE C/ZOCLO		
CLAVE	DESCRIPCIÓN	PIEZAS
E-2611	VINIL ALETA	-
EP-0124	EMPAQUE HONGO DECENTRADO	-
EP-0126	EMPAQUE VIDRIO DE HOJA	-
FN-110	FELPA CON PLÁSTICO	-
GN-611	ESCUADRA 500B	4
GN-147	BISAGRA	2
GN-618	ESCUADRA DE ALINEACIÓN	2
-	CHAPA	1

TABLA DE DESCUENTOS PUERTA C/INTERMEDIO Y ZOCLO			
CLAVE	DESCRIPCIÓN	No. DE PIEZAS	CORTE Y DESCUENTO
4596	BATIENTE	1	L
4596	BATIENTE	2	H
4590	CABEZAL	1	L-119
4590	CERCO CHAPA	2	H-70
4595	ZOCLO	1	H-224
4587	SELLO D/HERMETICIDAD	1	H-128
4594	JUNQUILLO	2	L-214
4594	JUNQUILLO	2	H-214
VIDRIO	L	1	L-236
	H		H-236

L= ANCHO DE VENTANA
H= ALTO DE VENTANA

DESCUENTOS EN MM.

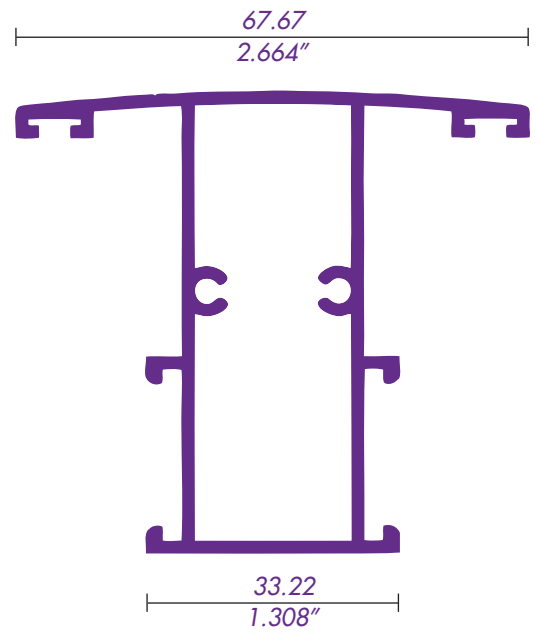
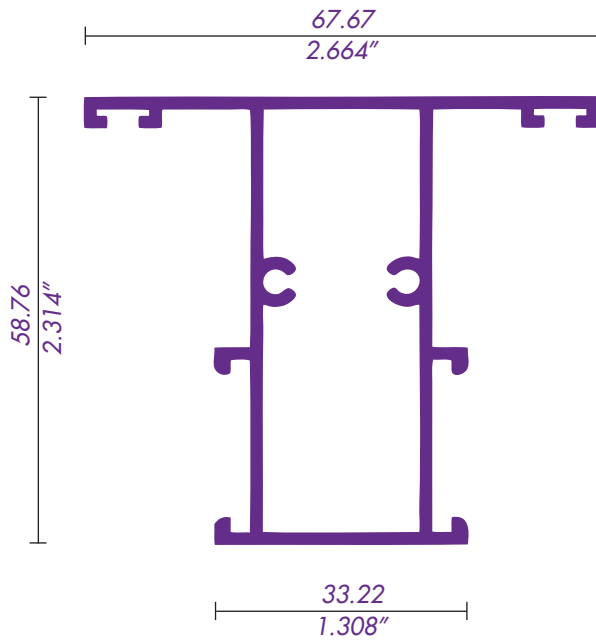
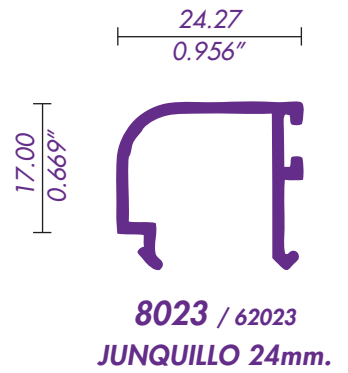
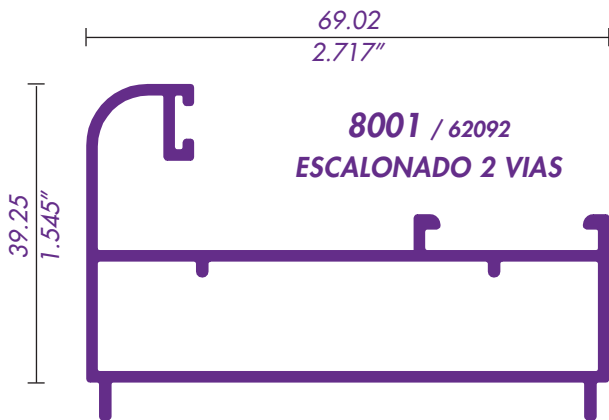
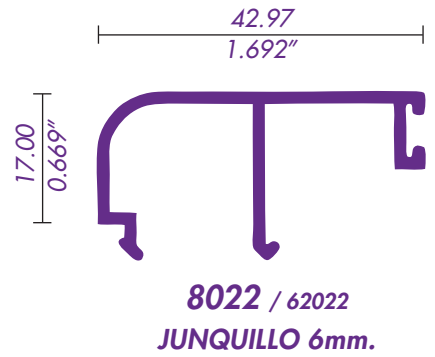
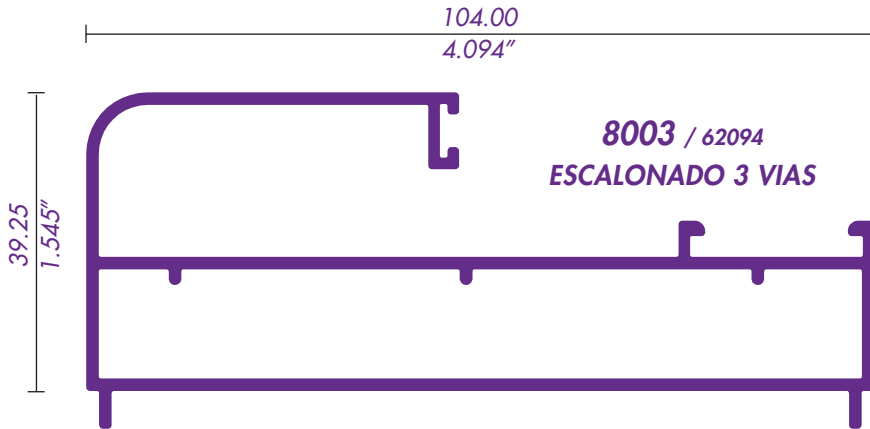



TABLA DE DESCUENTOS DOS HOJAS CORREDIZAS			
CLAVE	DESCRIPCIÓN	No. DE PIEZAS	CORTE Y DESCUENTO
8019	RIEL / CABEZAL	2	L
8019	JAMBA	2	H
8017	ZOCLO / CABEZAL	4	L/2-3
8017	CERCO / TRASLAE	4	H-73
8018	TAPA TRASLAPE	2	H-73
VIDRIO	L	2	L/2-110
	H		H-180
L= ANCHO DE VENTANA H= ALTO DE VENTANA		DESCUENTOS EN MM.	





8017 / 62001
CERCOS 6mm

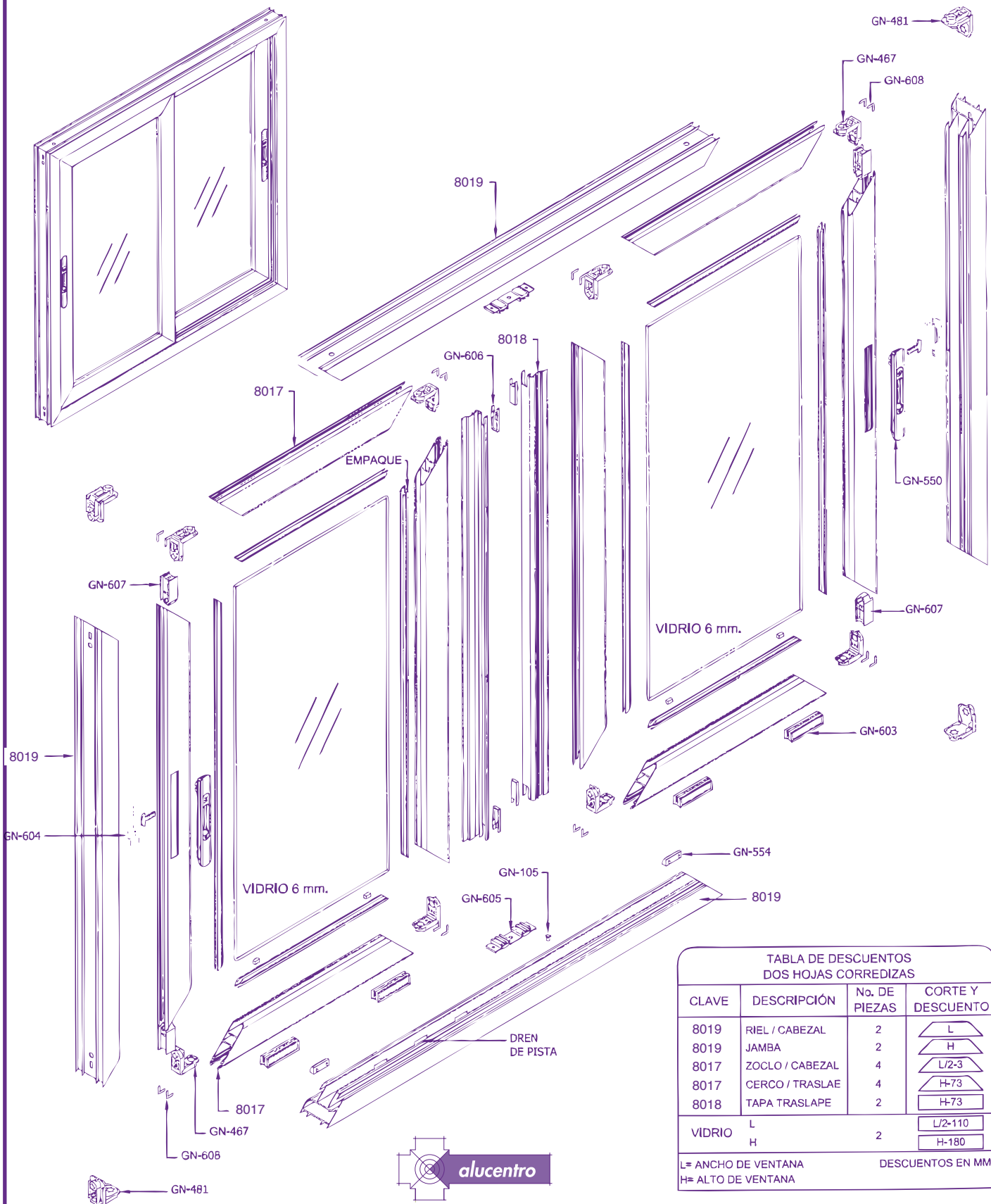
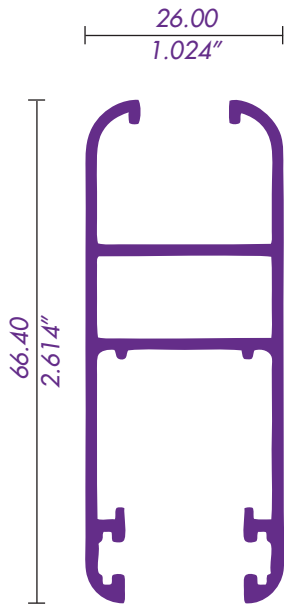
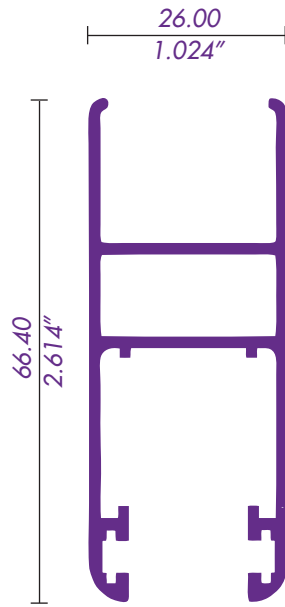

8027 / 62004
CERCOS DUO 18mm

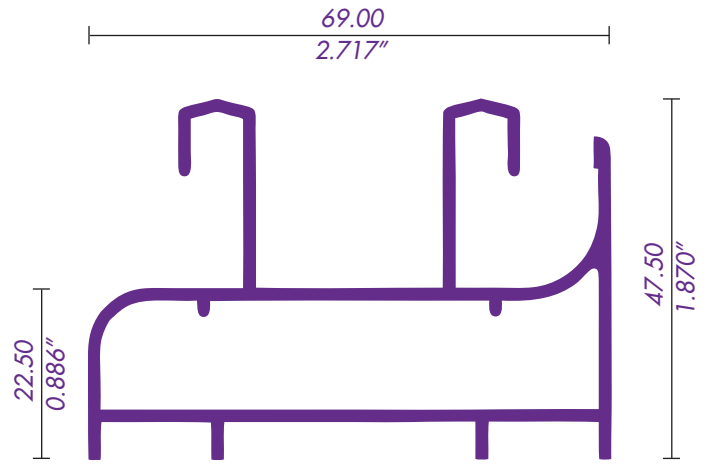

8019 / 62000
RIEL BASICO

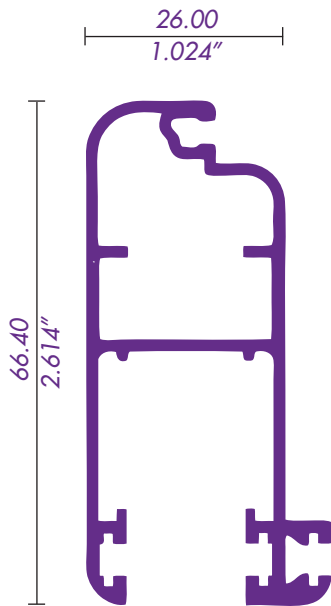

8012 / 62019
MOSQUITERO DE LUJO

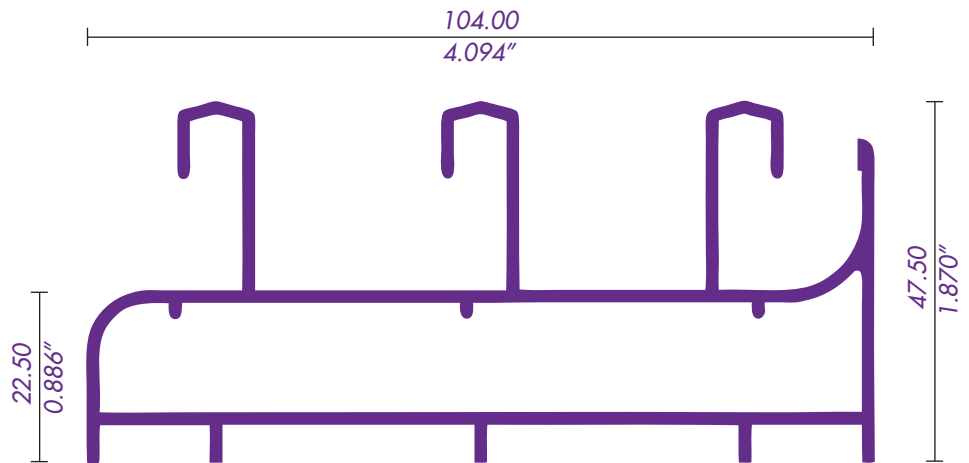

8029 / 62017
RIEL TRIPLE



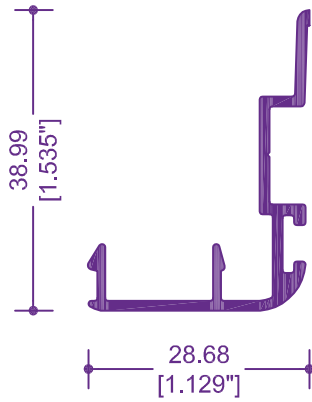

8018 / 62002
TRASLAPE

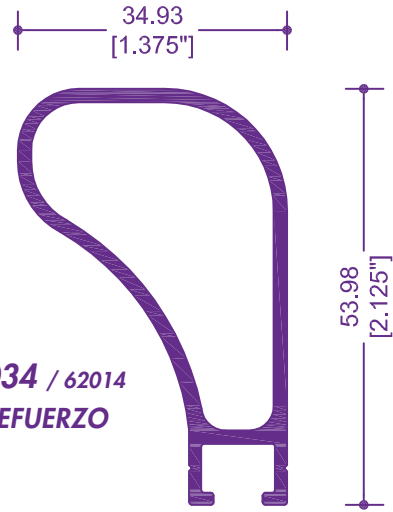

8034 / 62014
REFUERZO

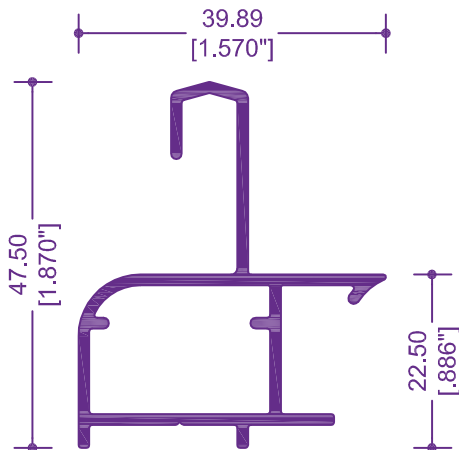

8021 / 64207
ADAPTADOR RIEL

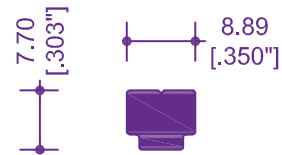

8035 / 14412
CONECTOR

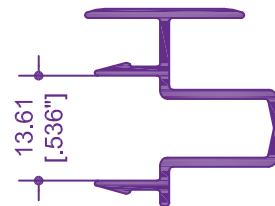

8043 / 62103
ADAPTADOR OXXO



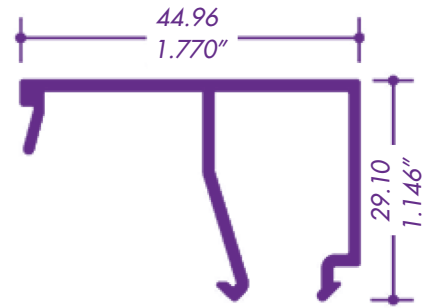
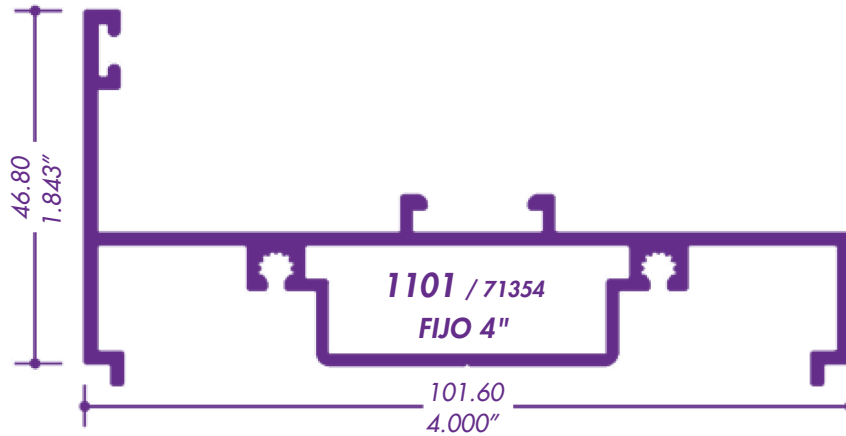

1104 / 71255
JUNQUILLO 6 MM

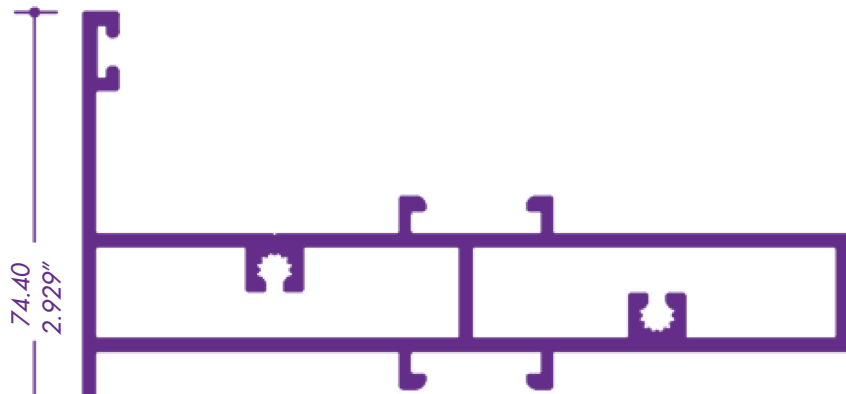

1102 / 71251
INTERMEDIO S-100 AR

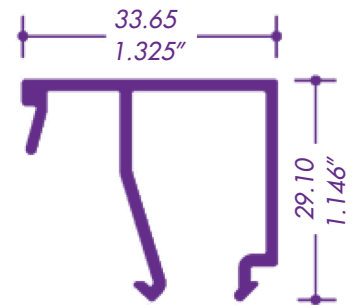

1105 / 71256
JUNQUILLO 14 MM

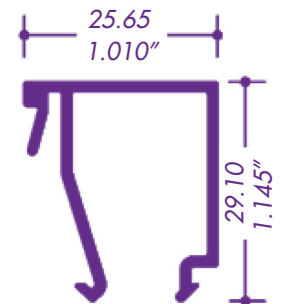
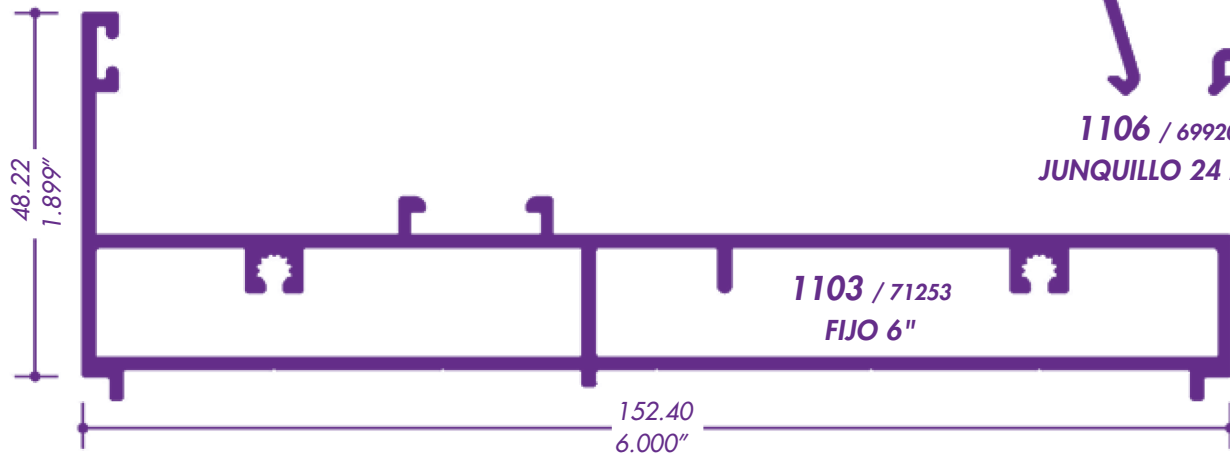

1106 / 69920
JUNQUILLO 24 MM



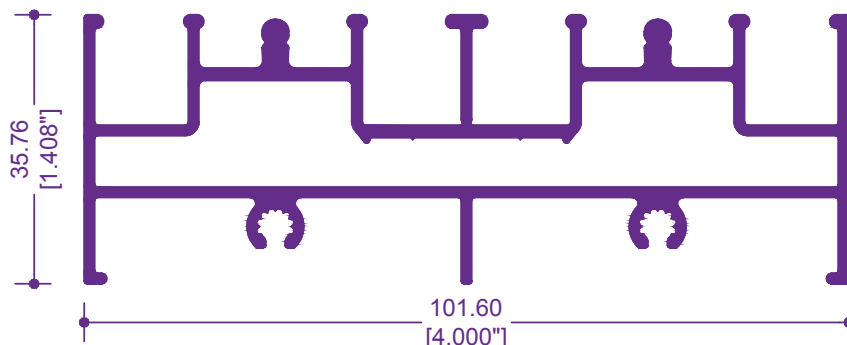

1110 / 72607
RIEL EMBUTIDO DOBLE

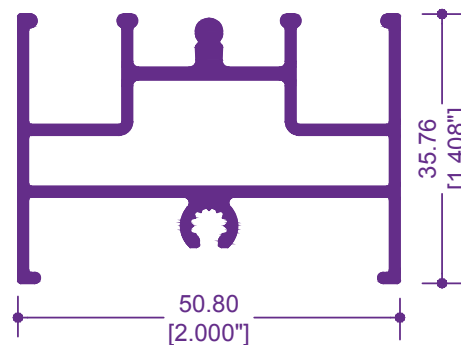

1111 / 72608
RIEL EMBUTIDO MULTIPLE

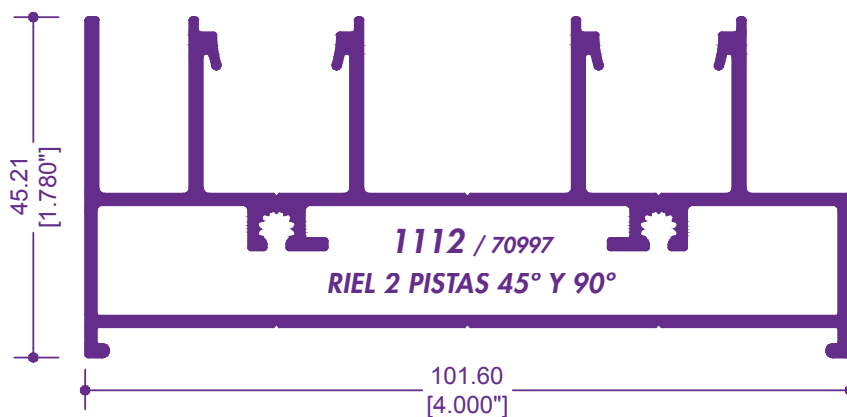

1112 / 70997
RIEL 2 PISTAS 45° Y 90°

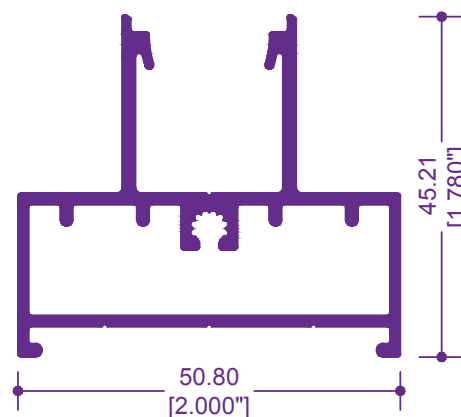

1113 / 71207
RIEL MULTIPLE 45° Y 90°

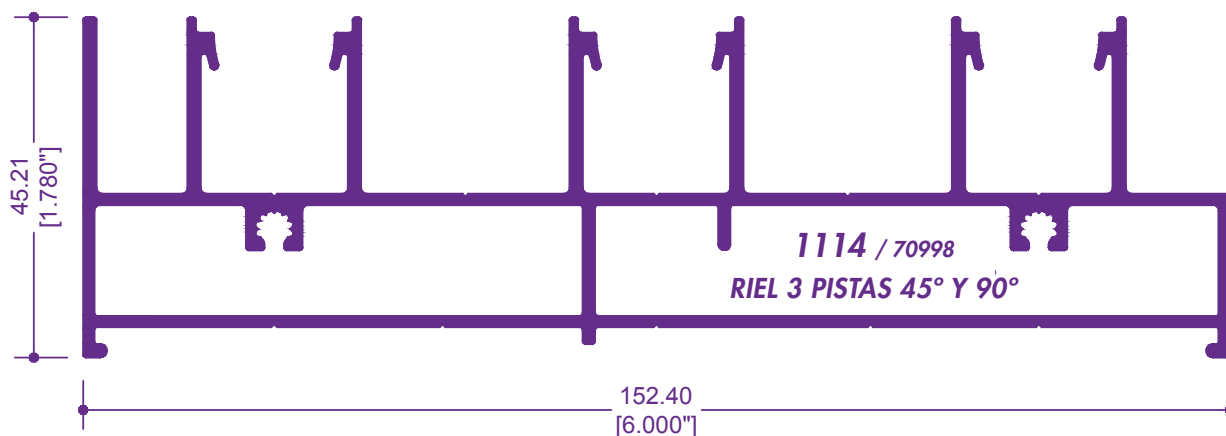

1114 / 70998
RIEL 3 PISTAS 45° Y 90°



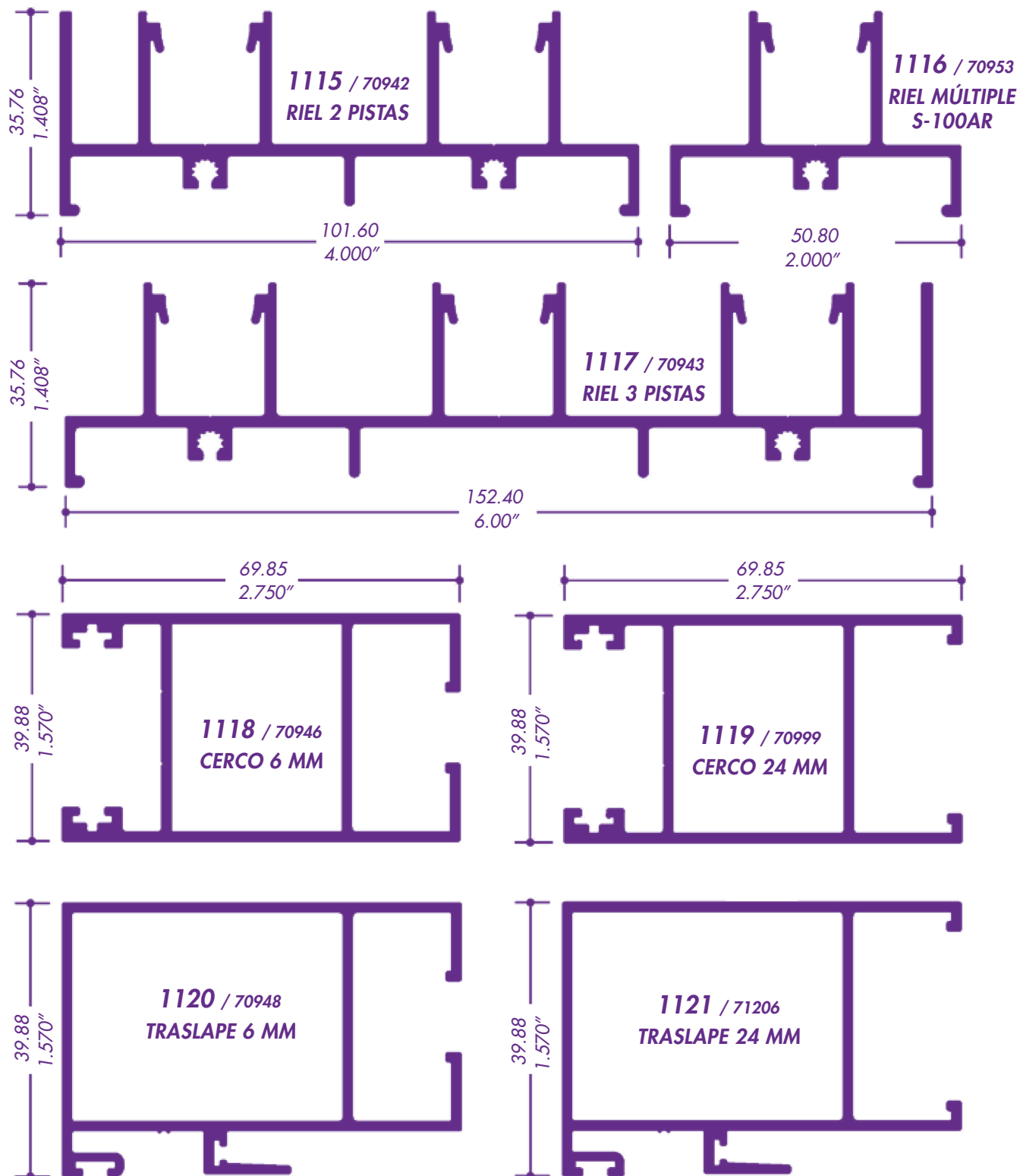

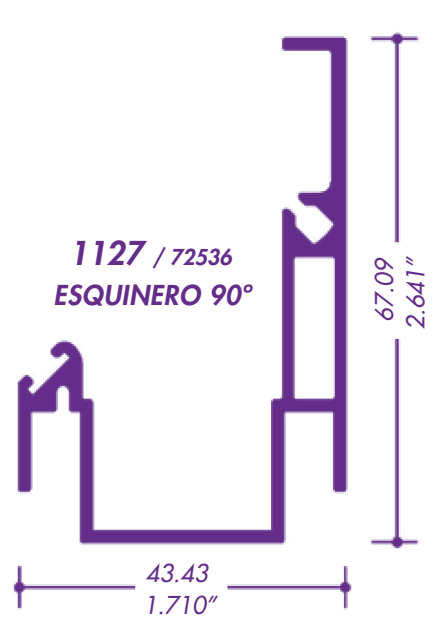
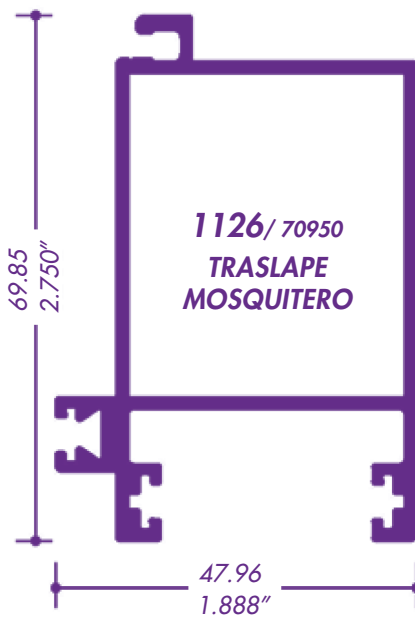
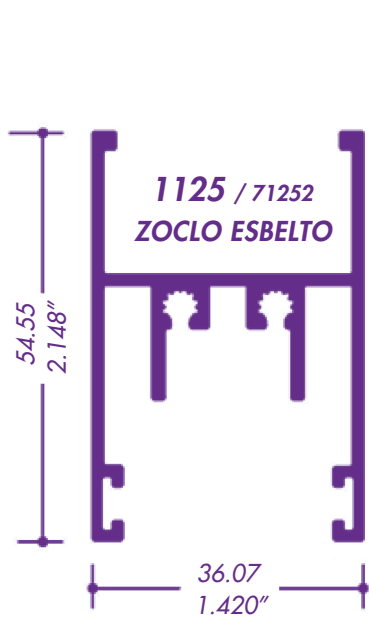
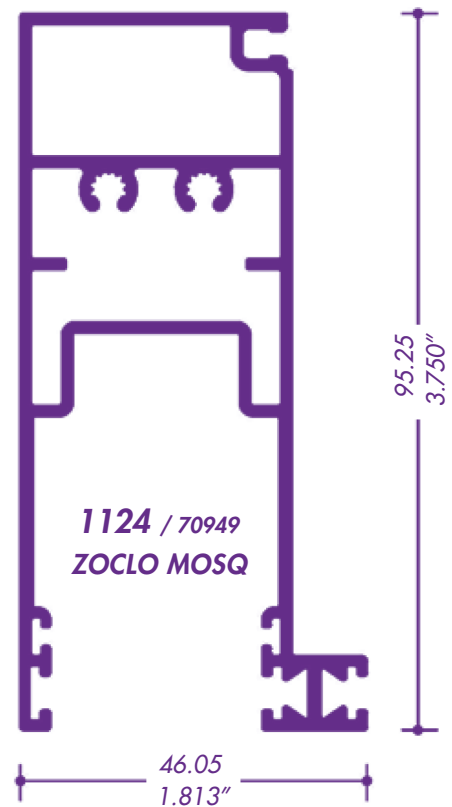
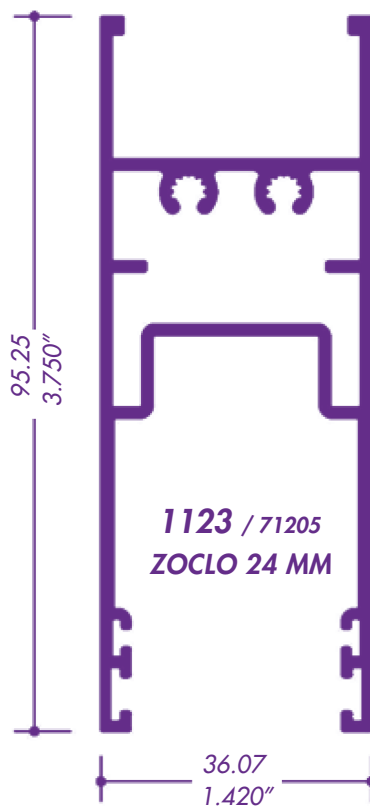
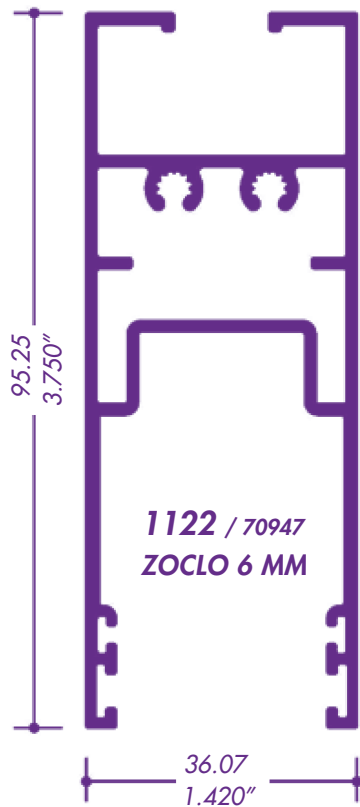

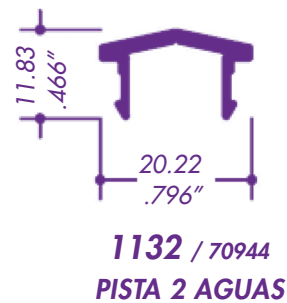
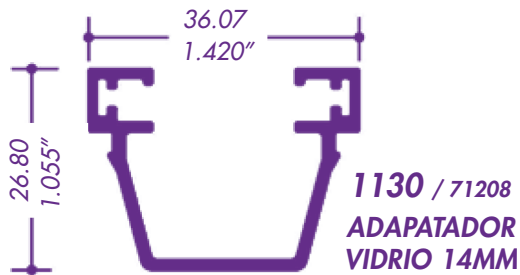
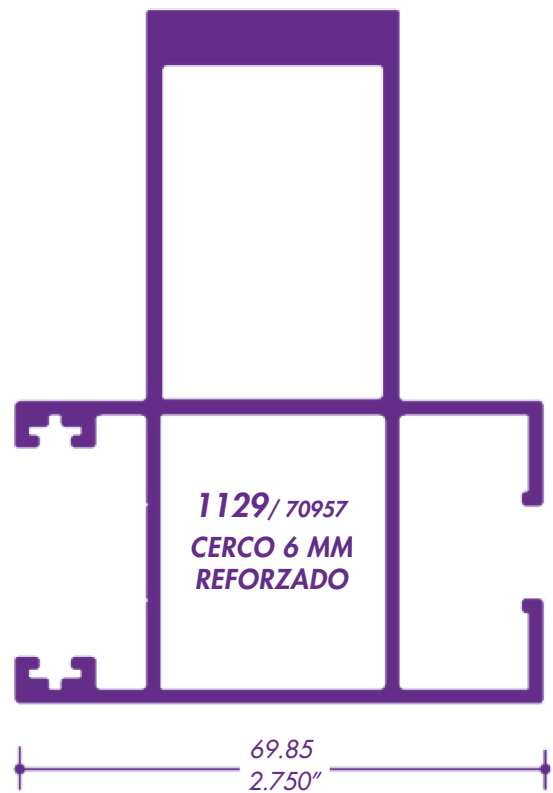
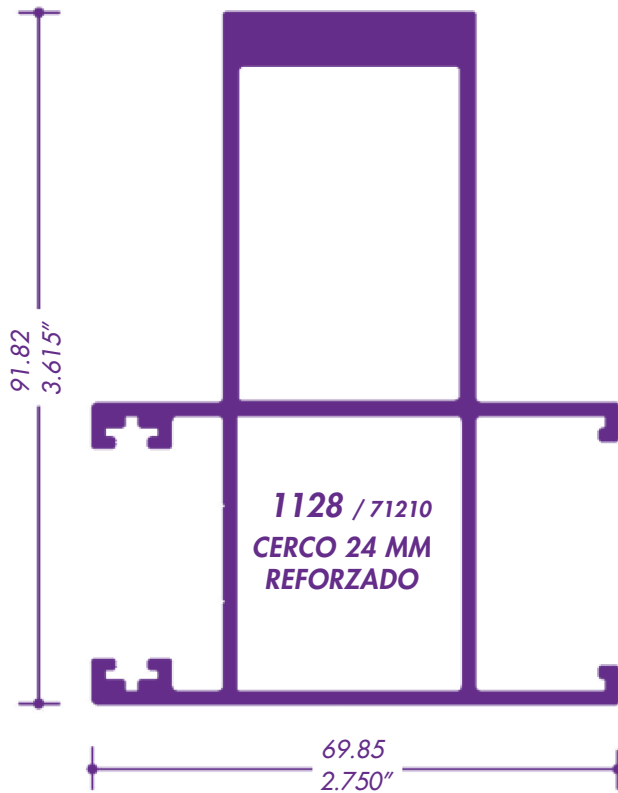

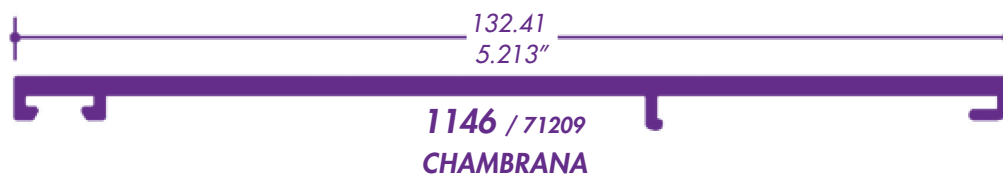
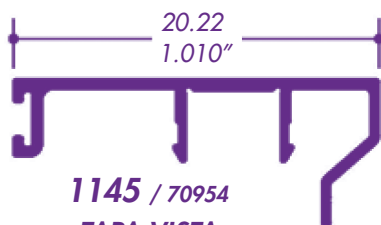
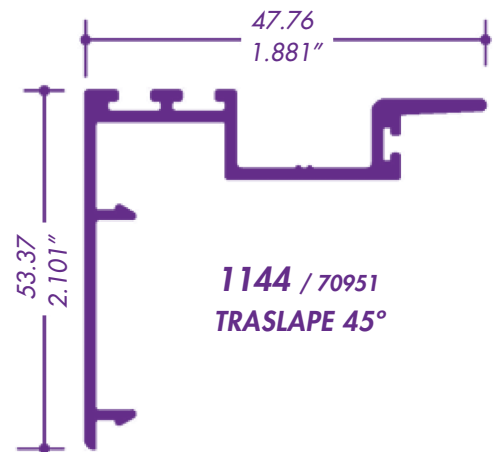
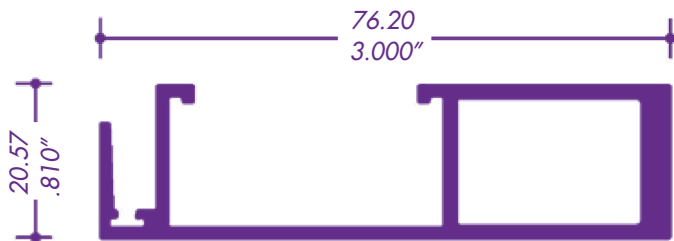
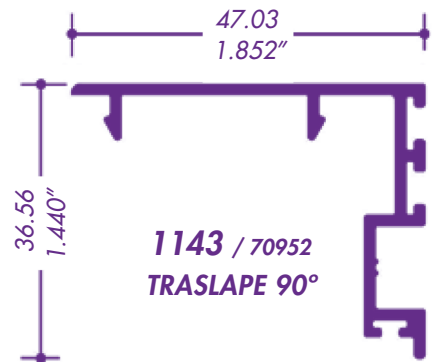
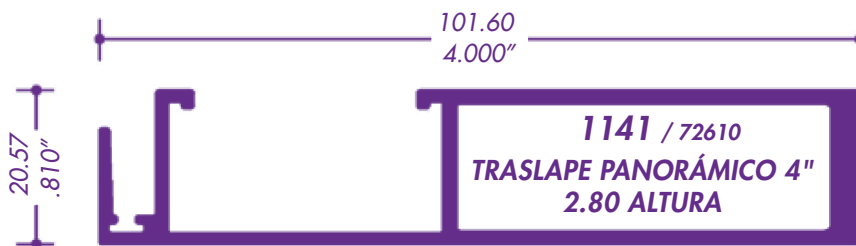
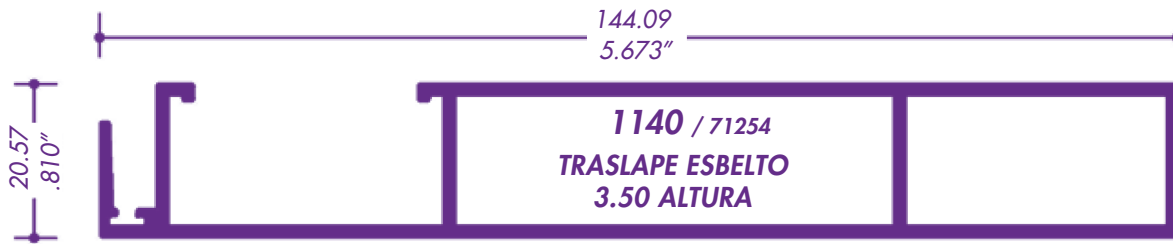

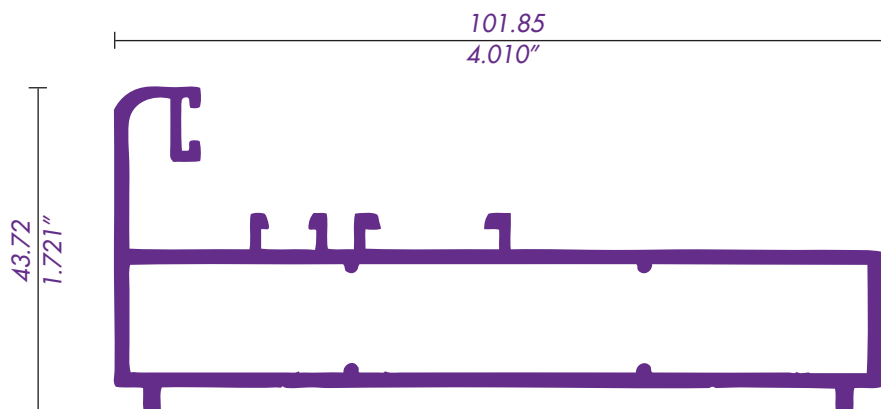

1522 / 67734
CONTRAMARCO

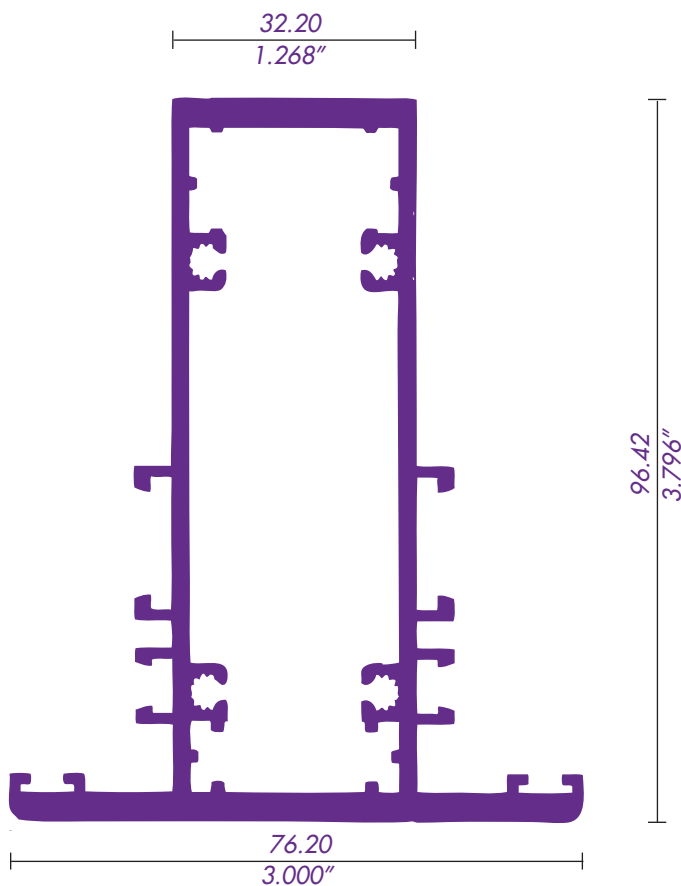

1505 / 67735
INTERMEDIO PARA FIJO

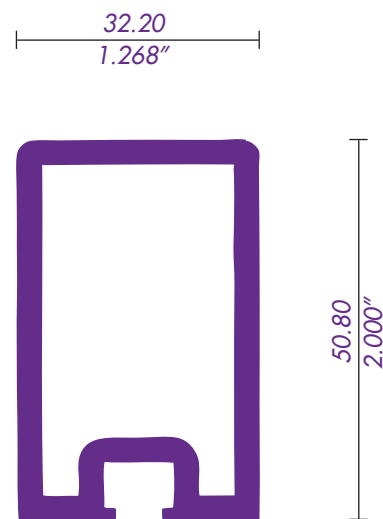

1506 / 67712
REFUERZO PARA INTERMEDIO

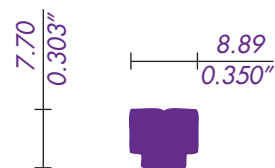

8035 / 14412
CONECTOR



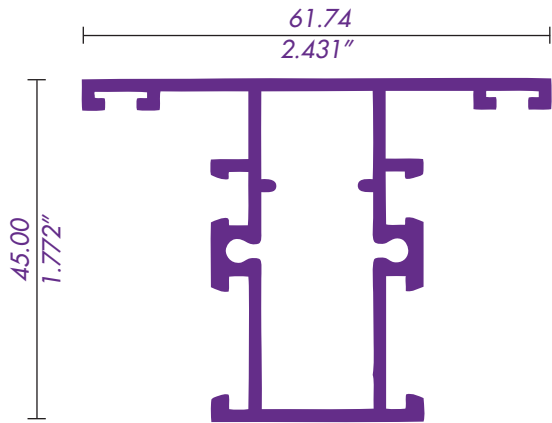

4521 / 62041
INTERMEDIO CUADRÍCULA

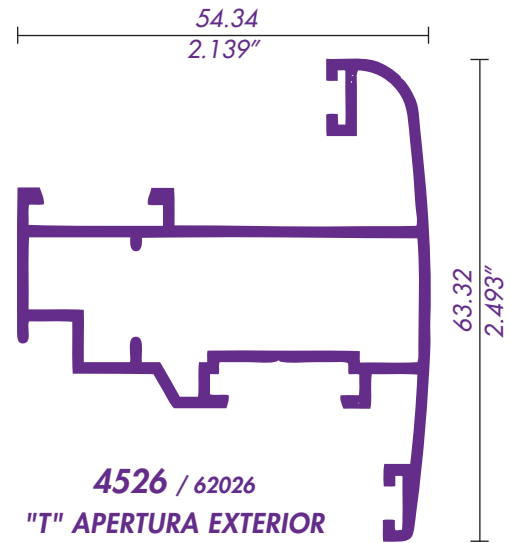

4526 / 62026
"T" APERTURA EXTERIOR

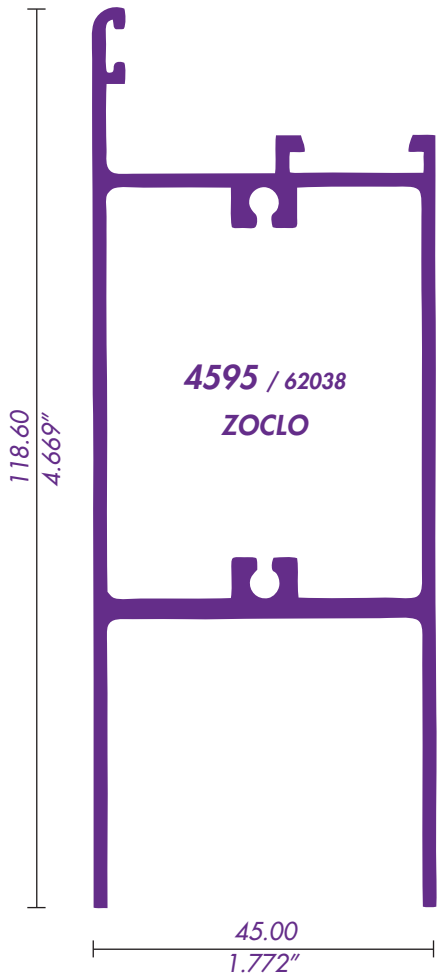

4595 / 62038
ZOCLO

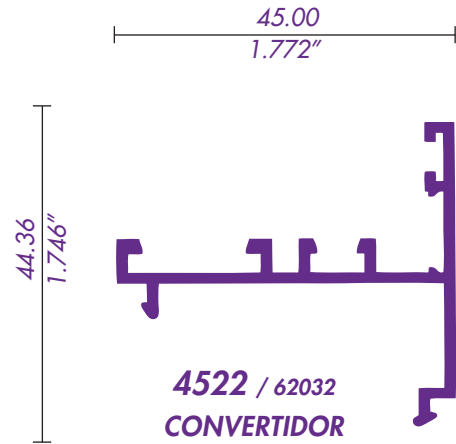

4522 / 62032
CONVERTIDOR

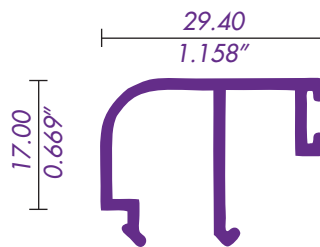

4594 / 62029
JUNQUILLO 6mm.

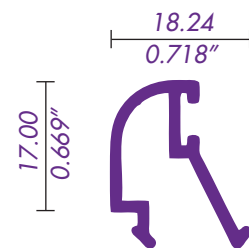

4593 / 62030
JUNQUILLO 24mm.



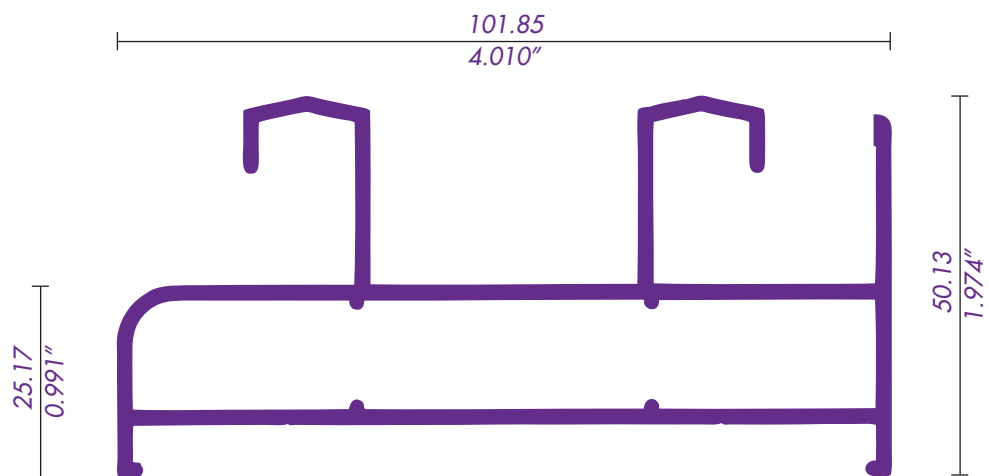

1519 / 62052
RIEL DOBLE

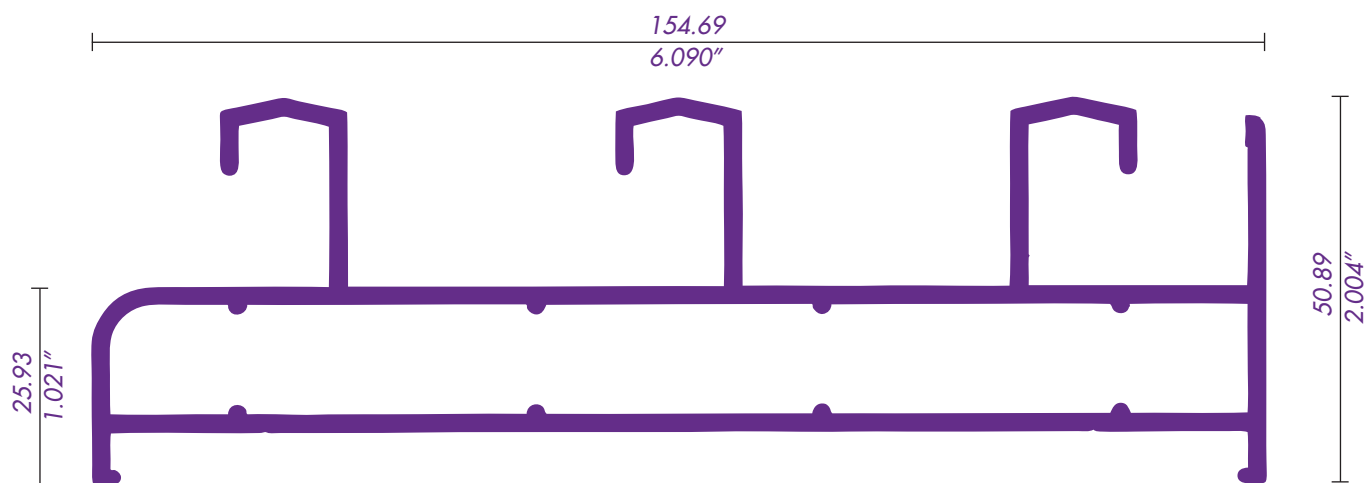

1529 / 62054
RIEL TRIPLE



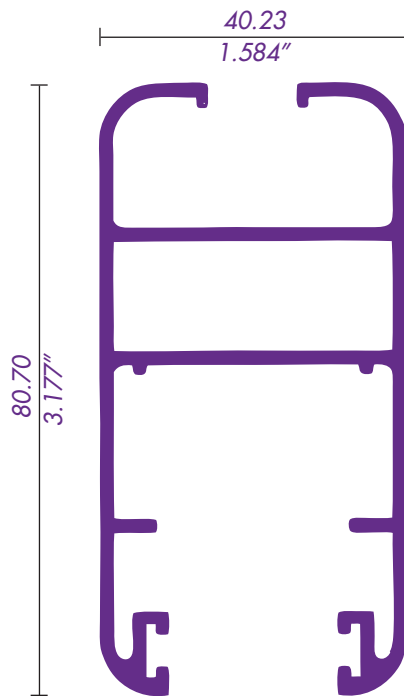

1517 / 62055
CERCO 6mm

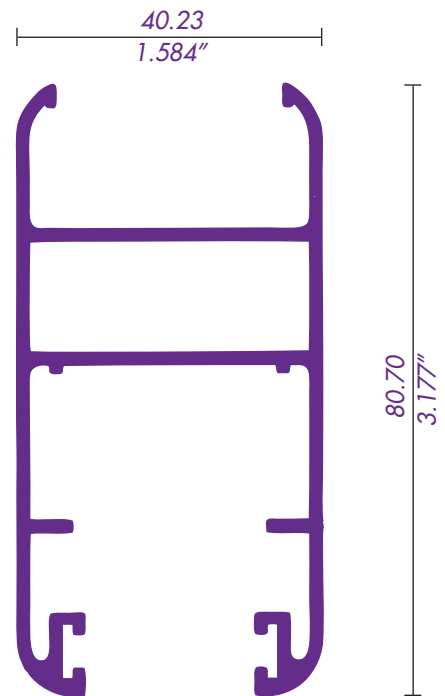

1527 / 62056
CERCO 24mm
DOBLE VIDRIO

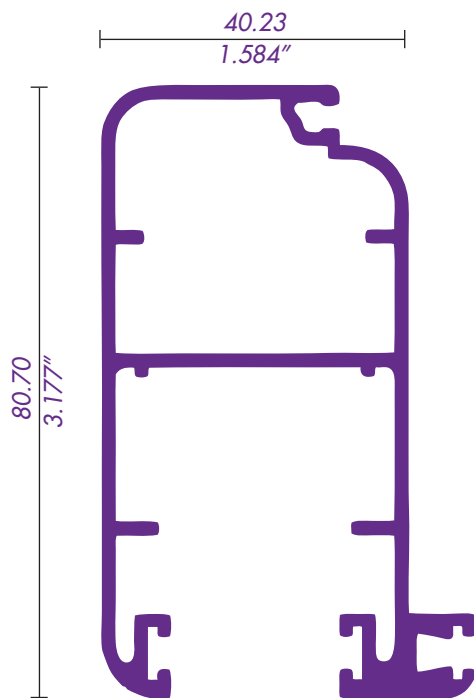

1512 / 62057
MOSQUITERO

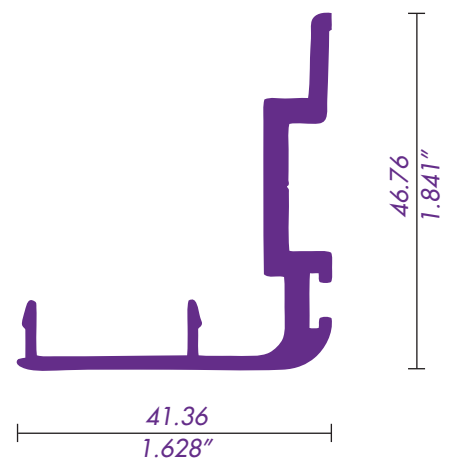

1518 / 62058
TRASLAPE



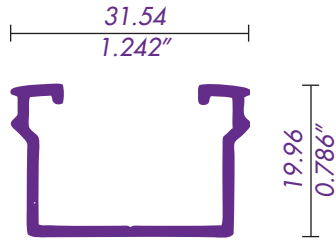

1516 / 62060
ADAPTADOR CRIS-
TAL 9mm

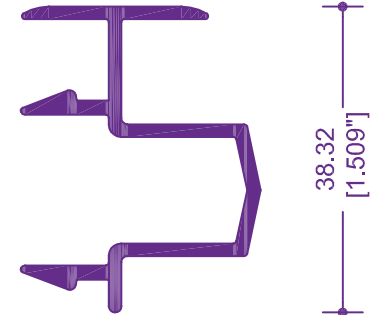

1543 / 64206
ADAPTADOR OXXO

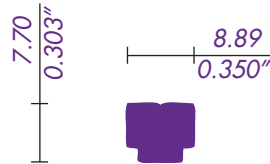

8035 / 14412
CONECTOR

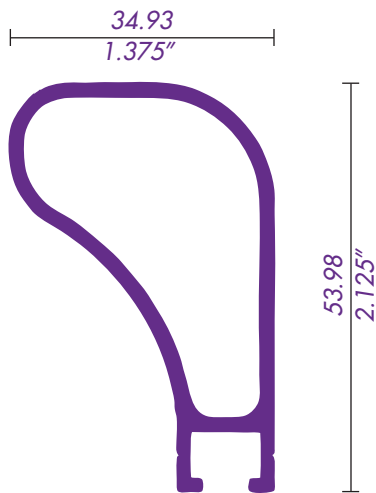

8034 / 62014
REFUERZO



1521 / 62091
ADAPTADOR RIEL



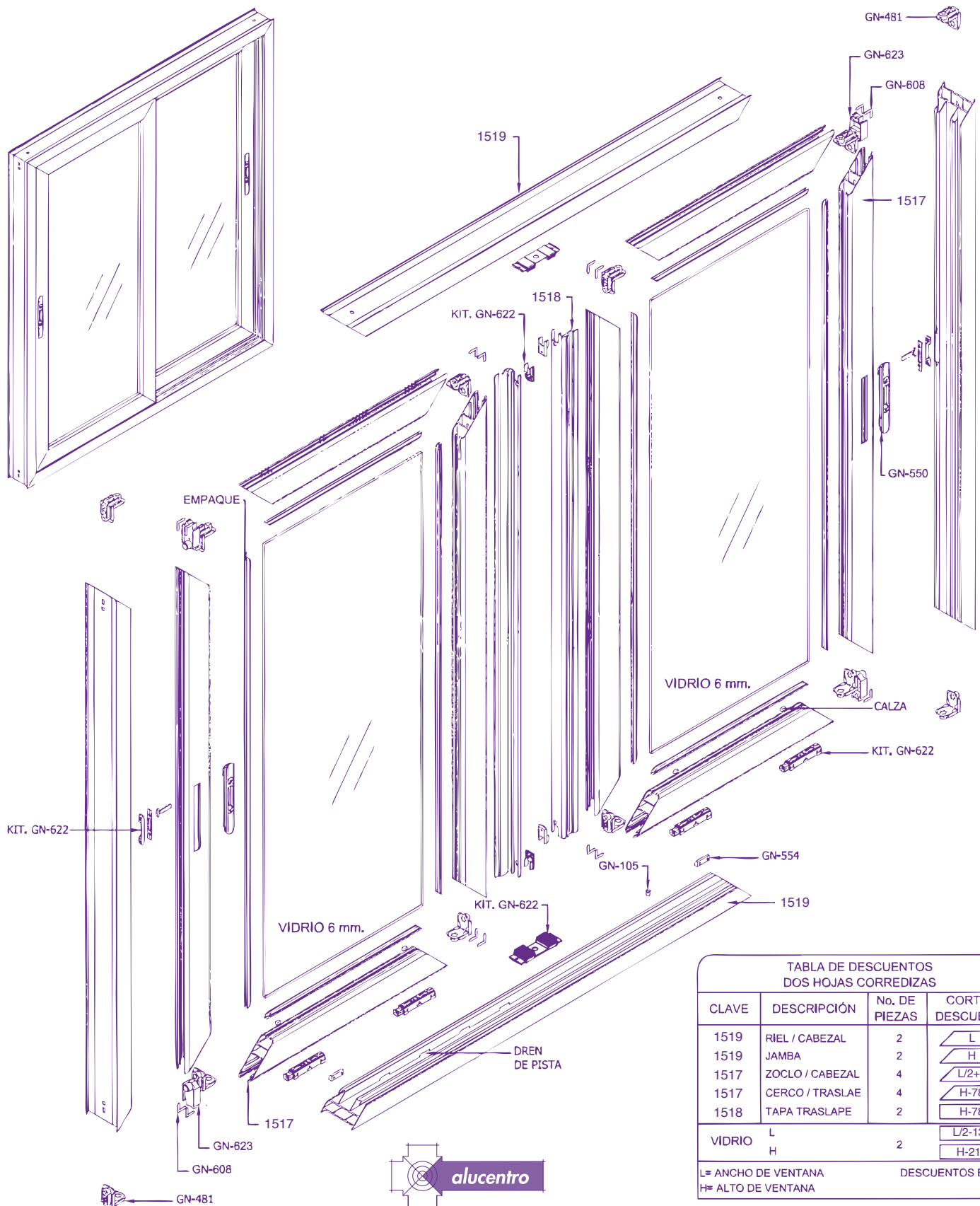

**TABLA DE DESCUENTOS
DOS HOJAS CORREDIZAS**

CLAVE	DESCRIPCIÓN	No. DE PIEZAS	CORTE Y DESCUENTO
1519	RIEL / CABEZAL	2	L
1519	JAMBA	2	H
1517	ZOCLO / CABEZAL	4	L/2+3
1517	CERCO / TRASLAE	4	H-78
1518	TAPA TRASLAPE	2	H-78
VIDRIO	L	2	L/2-138
	H		H-212

L= ANCHO DE VENTANA
H= ALTO DE VENTANA

DESCUENTOS EN MM



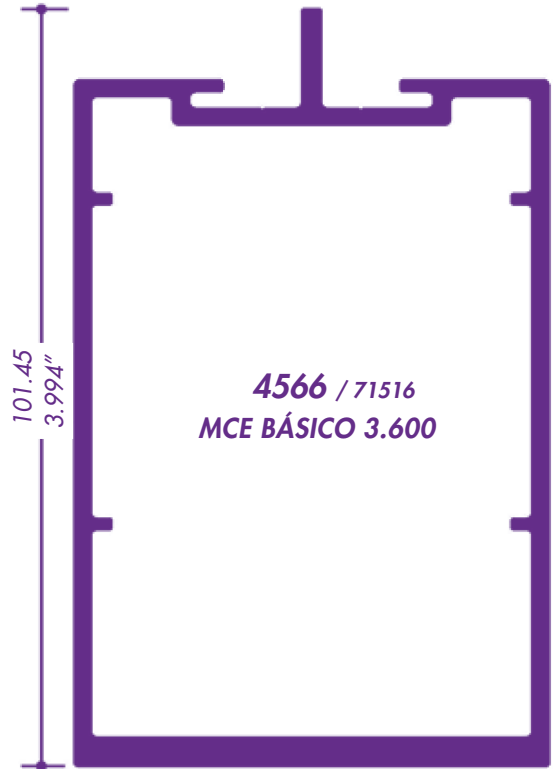
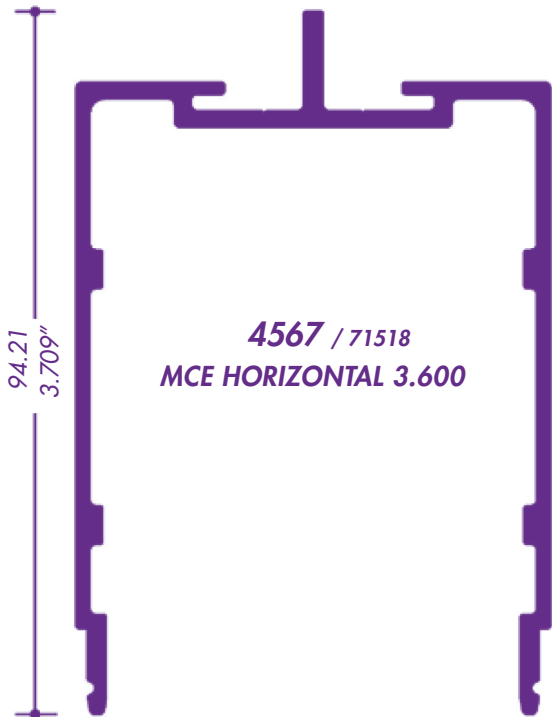
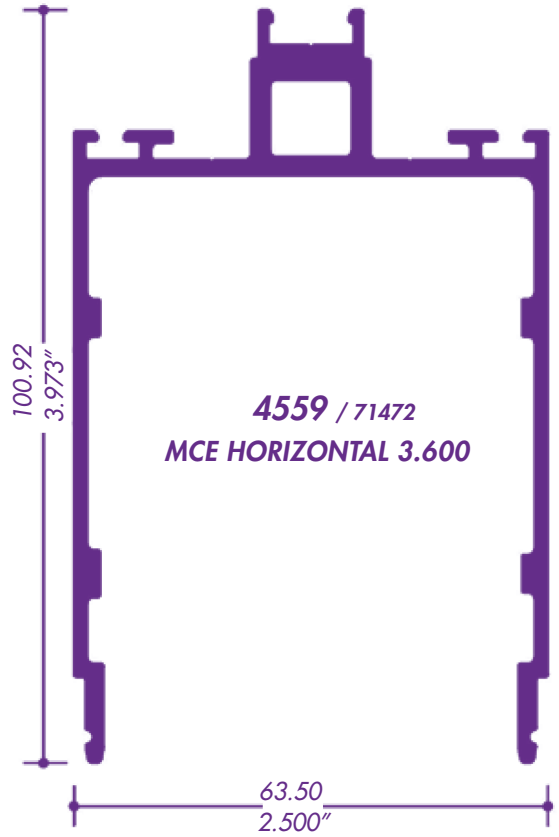
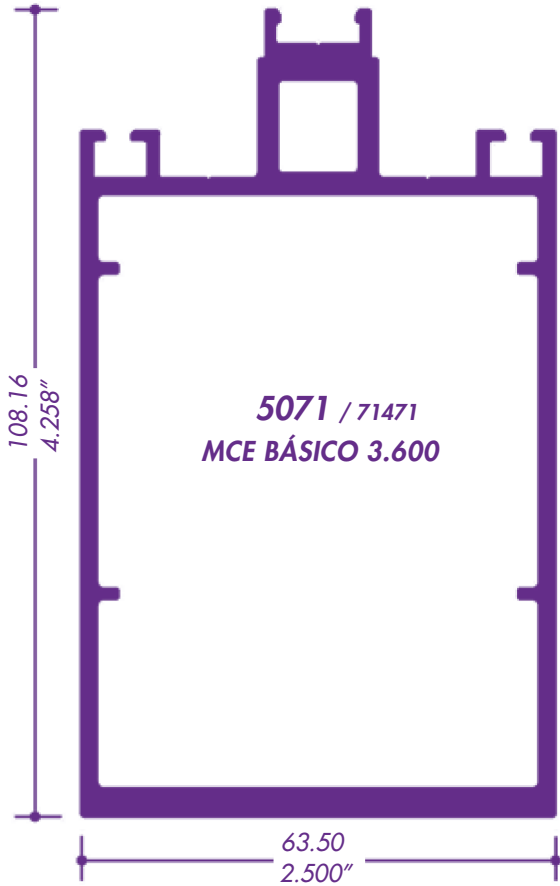

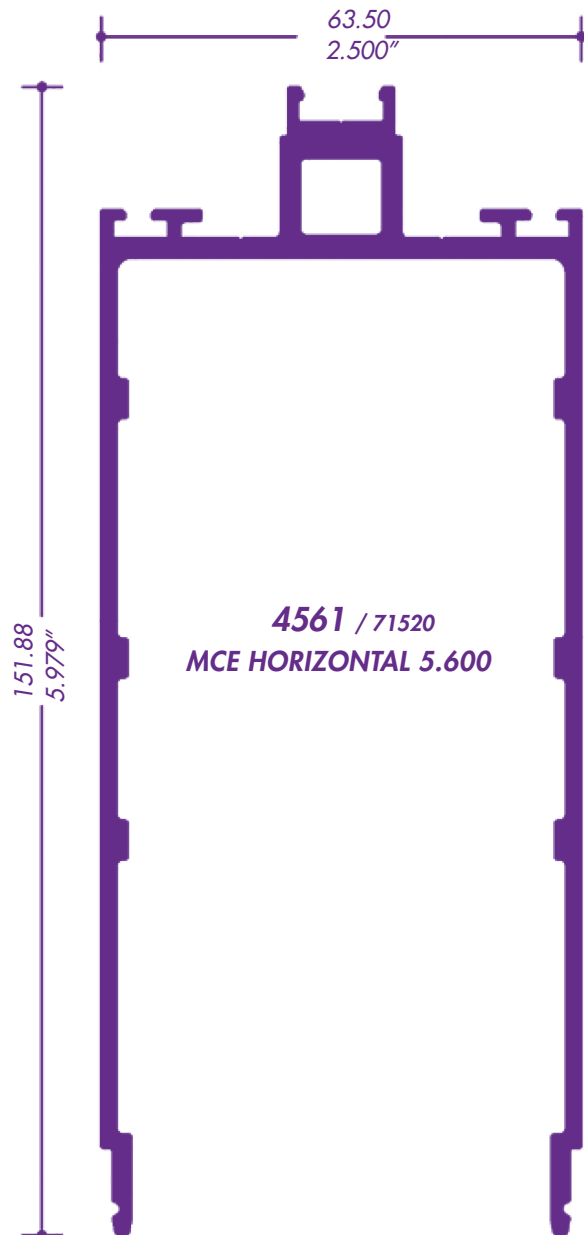
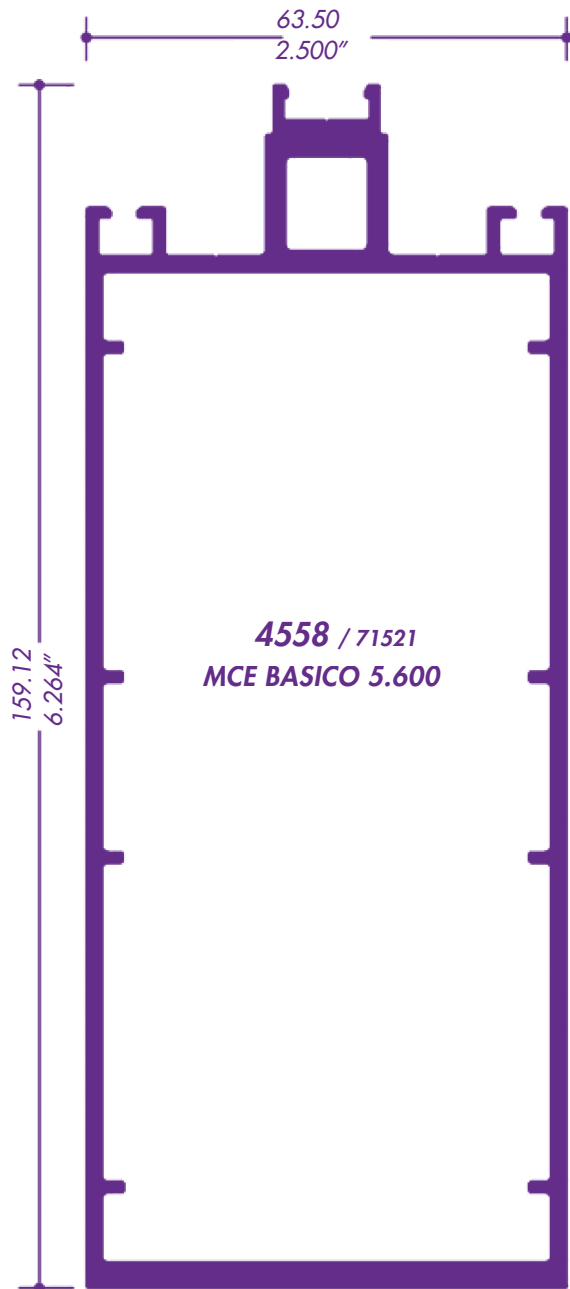

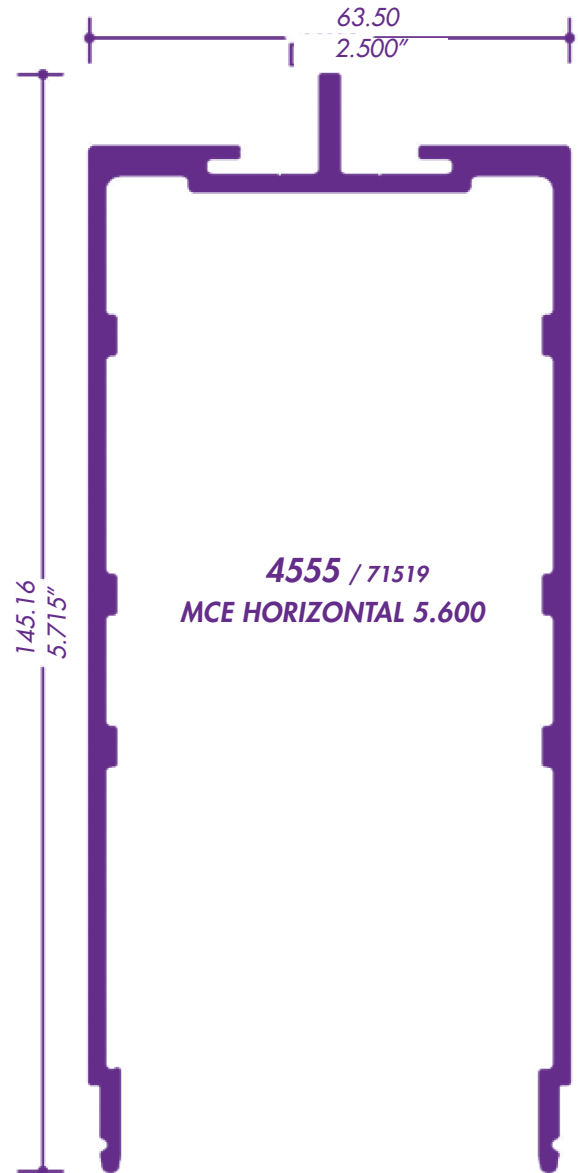
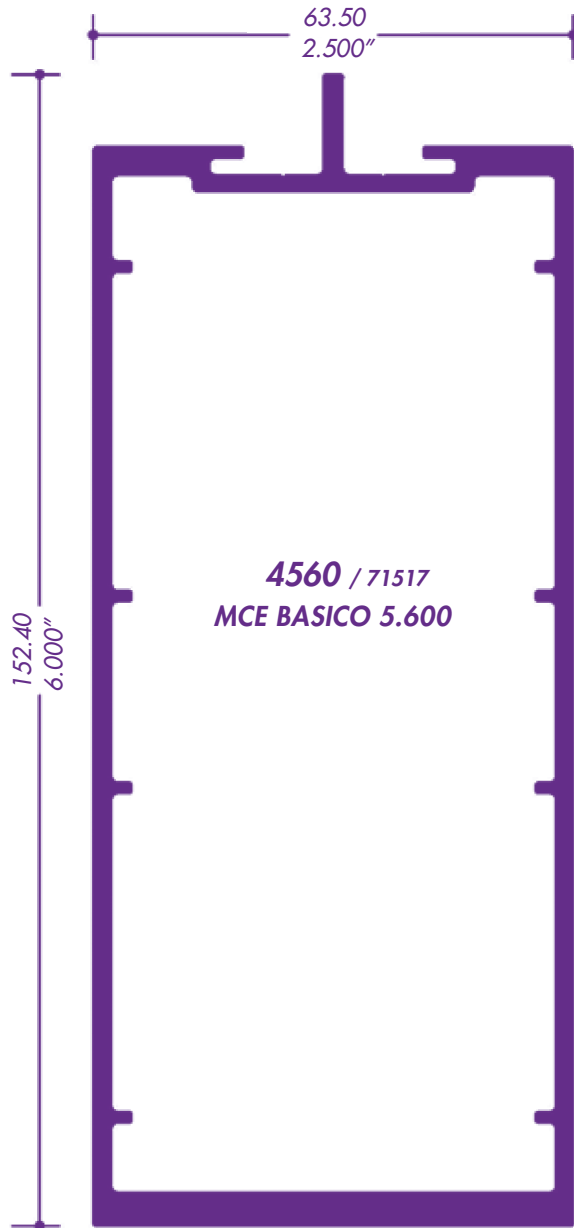

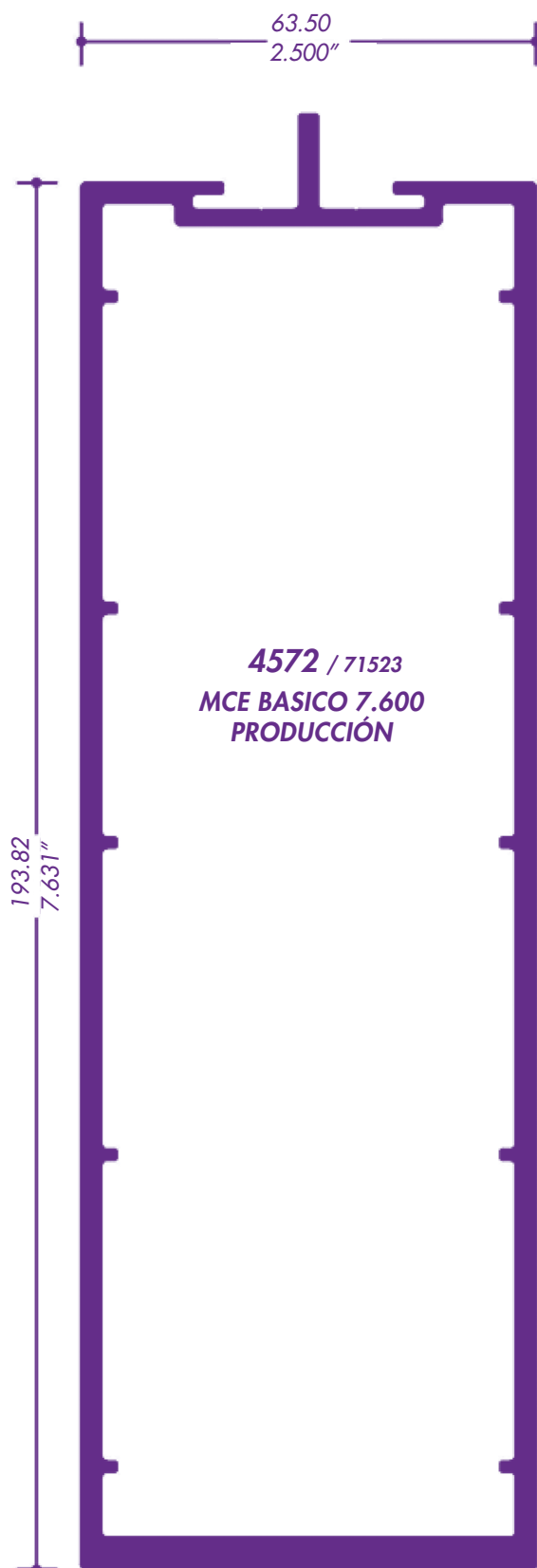
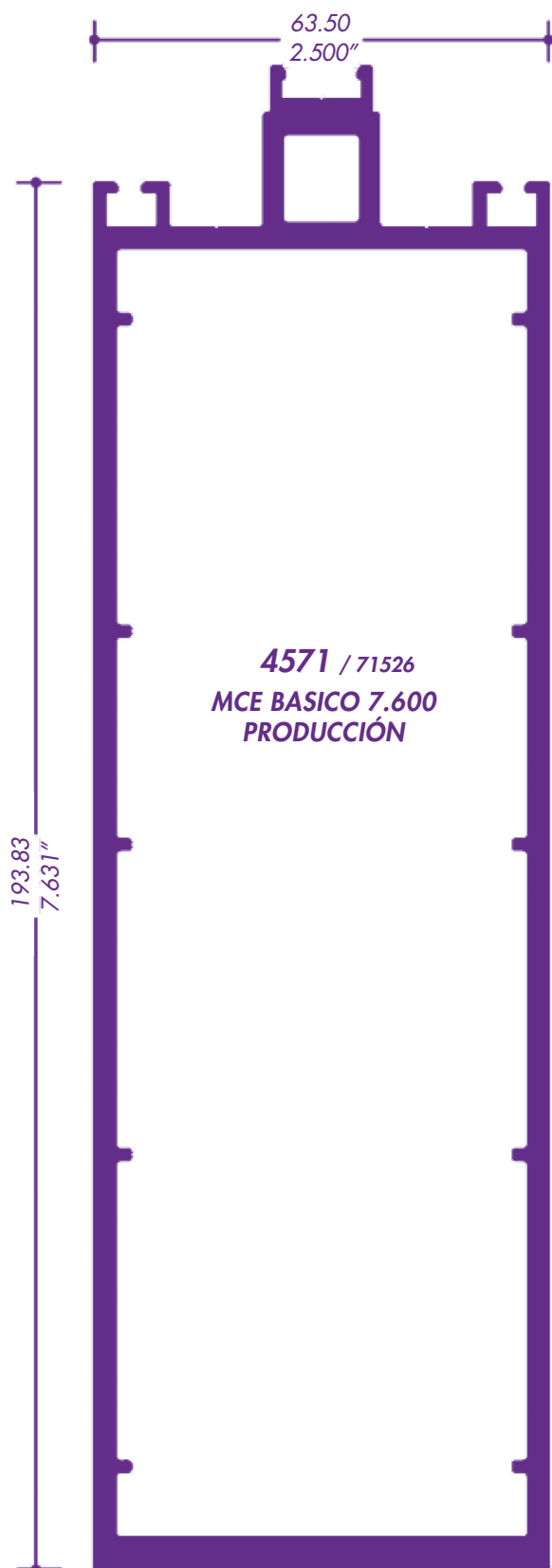

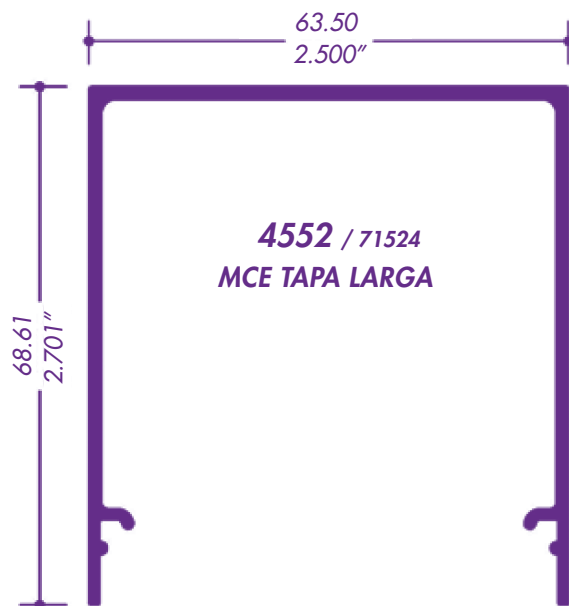
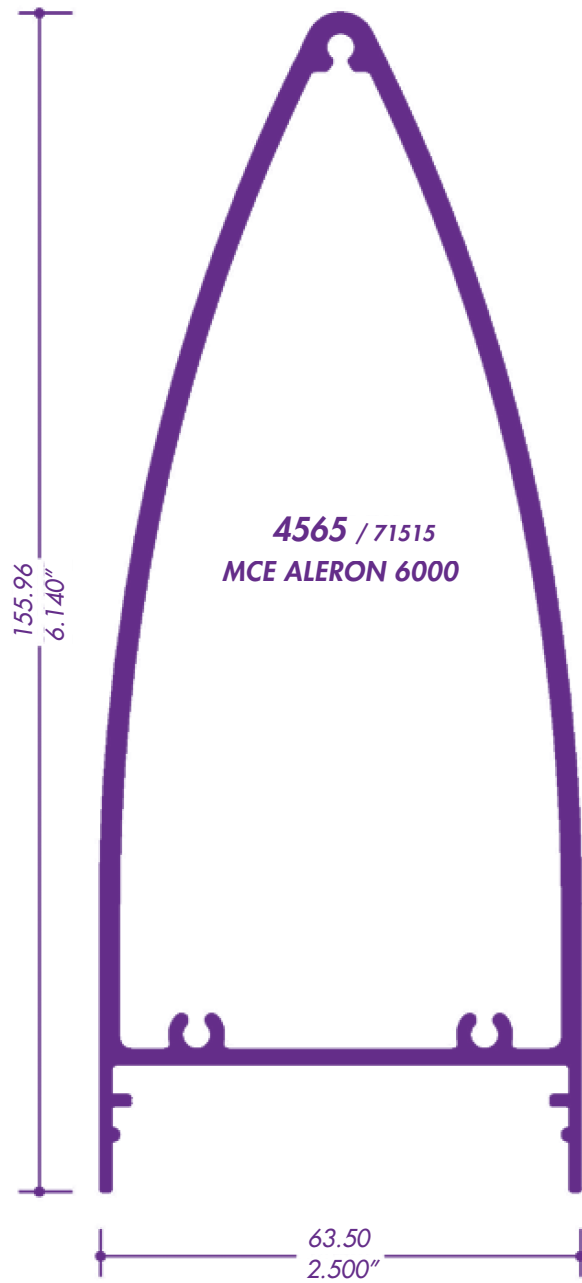
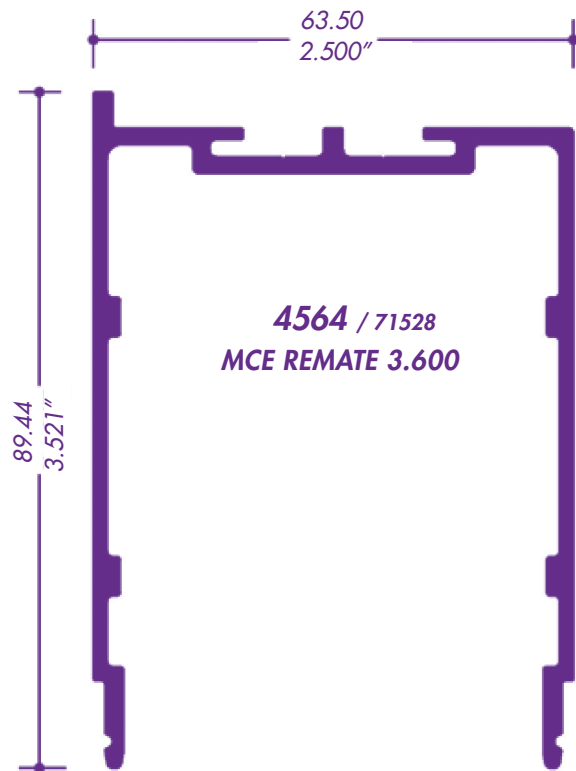

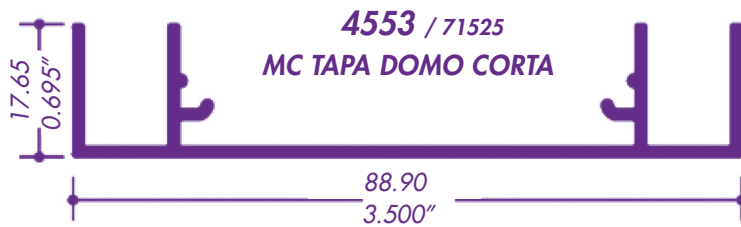
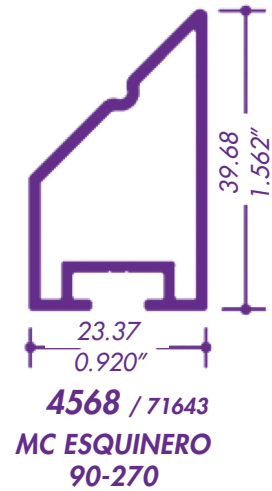
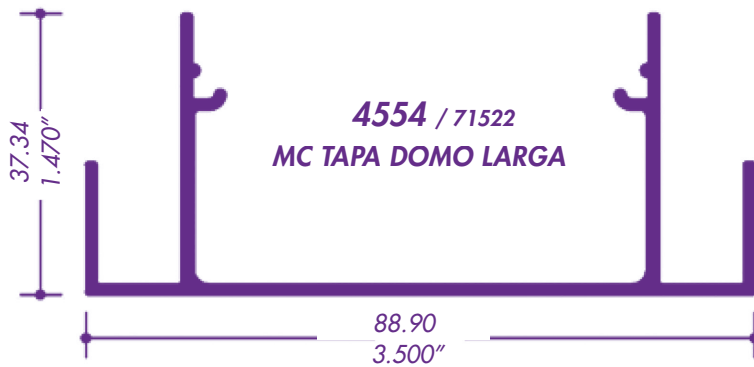
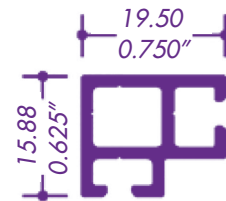
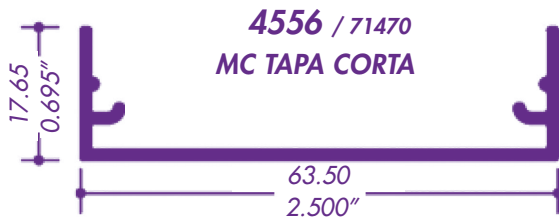
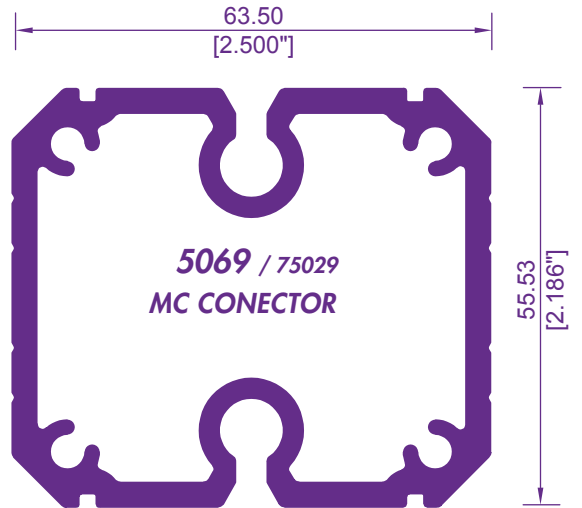
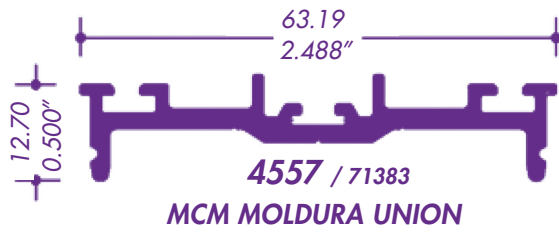

MURO CORTINA SERIE MC 450AD
VENTANA PROYECCIÓN

EUROVENT
PREMIUM

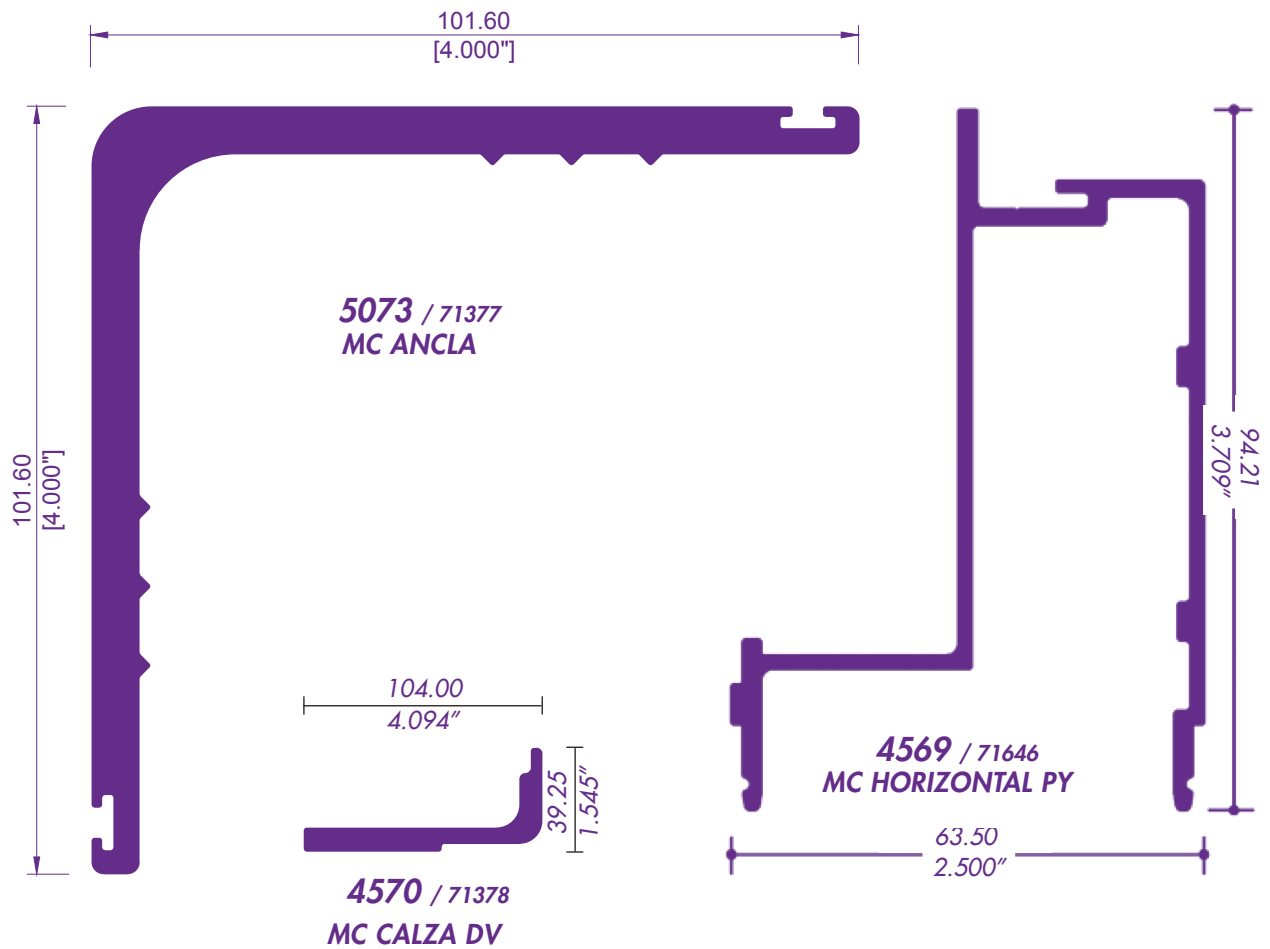
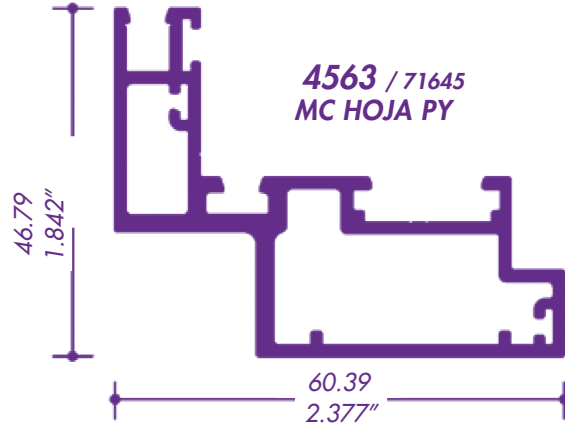
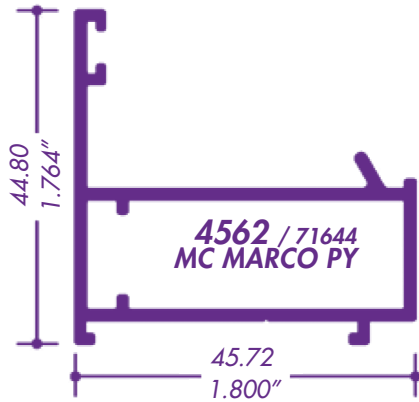

VENT BATIENTE S 45 APERTURA INT

CLAVE	DESCRIPCION	PZS
3823	BISAGRA FLASH BASE GN-451	2
3866	COMPAS LIMITADOR GN-457	1
3873	KIT CREMONA PRIMA REVERSIBLE GN-450	1
3877	ESCUADRA DE ALINEACION GN-618	4
3878	ESCUADRA BOTON GN-481	8
3922	TAPA DREN CON VALVULA GN- 554	2
3940	VINIL HONGO DESCENTRADO EP 124	
3941	VINIL HOJA EP-0126	
3942	VINIL HONGO HOJA EP-0135	
4529	PLETINA	
OPCIONAL		
3822	BISAGRA BRIDGE CRISTAL DUO GN-461	2

VENT BATIENTE S 45 APERTURA EXT

CLAVE	DESCRIPCION	PZS
3823	BISAGRA FLASH GN-451	2
3866	COMPAS LIMITADOR GN-457	1
3874	KIT APERTURA EXTERIOR (CONTIENE) CREMONA UNICA, FUNCION REVERSIBLE GN-471	1
	EJE 18 MM BT GN-472	2
	ENCUENTRO DOBLE GN-477	2
	JGO APERTURA UNICA GN-472	1
	TERMINAL PLETINA GN-476	2
3878	ESCUADRA BOTON GN-481	8
3877	ESCUADRA DE ALINEACION GN-618	4
3910	POSICIONADOR DE HOJA GN-458	1
3940	VINIL HONGO DESCENTRADO EP-124	
3941	VINIL HOJA EP-0126	
3942	VINIL HONGO HOJA EP-0135	
4529	PLETINA	

FIJO 2 CLAROS SERIE 45

CLAVE	DESCRIPCION	PZS
3867	CONECTOR BERNINA GN-612	2
3878	ESCUADRA DE BOTON GN-481	4
3922	TAPA DREN CON VALVULA GN-554	2
3941	VINIL HOJA EP-0126	



VENTANA PROYECCION SERIE 45

CLAVE	DESCRIPCION	PZS
3823	BISAGRA FLASH GN-451	2
3829	BRAZO TELESCOPICO LASER GN-486 Ó	1
3869	COMPAS CORTO 1981 GN-489 60X60 MAXIMO	1
3877	ESCUADRA DE ALINEACION GN-618	4
3878	ESCUADRA DE BOTON GN-481	8
3902	MANIJA DE PROYECCION TABELLINO GN-487	1
3940	VINIL HONGO DESCENTRADO EP 124	
3941	VINIL HOJA EP-0126	
3942	VINIL HONGO HOJA EP-0135	
4529	PLETINA	

OPCIONAL

3822	BISAGRA BRIDGE GN.461 (DOBLE CRISTAL)	
------	---------------------------------------	--

VENTANA OSCIOBATIENTE SERIE 45

CLAVE	DESCRIPCION	PZS
3807	KIT OSCIOBATIENTE BRAZO CORTO	
	COMPAS CORTO	1
	CREMONA OSCIOBATIENTE GN-452	1
3877	ESCUADRA DE ALINEACION GN-618	4
3878	ESCUADRA DE BOTON 421 GN-481	8
3903	MECANISMO BASE GN-453	1
3922	TAPA DREN CON VALVULA GN-554	2

VENTANA OSCIOBATIENTE SERIE 45

CLAVE	DESCRIPCION	PZS
3806	KIT OSCIOBATIENTE BRAZO LARGO	
	COMPAS LARGO	1
	CREMONA OSCIOBATIENTE GN-452	1
3877	ESCUADRA DE ALINEACION GN-618	4
3878	ESCUADRA DE BOTON 421 GN-481	8
3903	MECANISMO BASE GN-453	1
3922	TAPA DREN CON VALVULA GN-554	2
3940	VINIL HONGO DESCENTRADO EP 124	
3941	VINIL HOJA EP-0126	
3942	VINIL HONGO HOJA EP-0135	



VENTANA VASISTA SERIE 45

CLAVE	DESCRIPCION	PZS
3824	BISAGRA OCULTA GN-462	2
3858	CIERRE GOLPETE CICO GN-459	1
3865	COMPAS ABATIBLE RALLENTY GN-460	2
3877	ESCUADRA DE ALINEACION GN-618	4
3878	ESCUADRA BOTON GN-481	8
3922	TAPA DREN CON VALVULA GN-554	2
3940	VINIL HONGO DESCENTRADO EP-124	
3941	VINIL HOJA EP-0126	
3942	VINIL HONGO HOJA EP-0135	

OPCIONALES

3822	BISAGRA BRIDGE CRISTAL DUO GN-461	2
3823	BISAGRA FLASH FUTURA CRISTAL 6 MM GN-451	2
3873	KIT CREMONA PRIMA FUNCION REVERSIBLE GN-450	1

PUERTA BATIENTE CE SERIE 45

CLAVE	DESCRIPCION	PZS
3823	BISAGRA FLASH FUTURA GN-451	2
3878	ESCUADRA BOTON GN-481	4
3867	CONECTOR BERNINA GN-612	2
3877	ESCUADRA DE ALINEACION GN-618	4
3846	CHAPA CVL TENSOSES	1 1
3945	VINIL ALETA E-2611	
3940	VINIL HONGO DESCENTRADO EP-124	
3941	VINIL VIDRIO EP-126	
3942	VINIL HONGO EP-135	

PUERTA BATIENTE / CERCO PERIMETRAL S 45

CLAVE	DESCRIPCION	PZS
3821	BISAGRA GN-147	2
3882	ESCUADRA GN-611	6
3877	ESCUADRA DE ALINEACION GN-618	4
3846	CHAPA CVL	1
3889	FELPA CON PLASTICO FN-110	
3940	VINIL HONGO DESCENTRADO EP-124	
3941	VINIL VIDRIO HOJA EP-126	



CORREDIZA SERIE 80 XX

CLAVE	DESCRIPCION	PZS
3854	CIERRE EMBUTIDO S-80	2
3837	CANDADO DE HOJA GN-607	4
3842	CARRETILLA AJUSTABLE GN-601 15kg	4
3862	CORTAVIENTOS GN-605	2
3876	ESCUADRA DE ALINEACION GN-608	16
3878	ESCUADRA DE BOTON GN-481	4
3879	ESCUADRA DE BOTON GN-467	8
3921	TAPON DESAGUE GN-105	1
3922	TAPA DREN CON VALVULA GN-554	2
3918	TAPA TRASLAPE GN-606	4
3889	FELPA CON PLASTICO FN-110	
852	CUÑA 12 AMBOS LADOS	
852	CUÑA 12 UN LADO	
OPCIONAL		
3843	CARRETILLA PABOSE GN-614 50K/PZA	
NOTA**		
EN TRIPLE RIEL AGREGAR:		
3878	ESCUADRA DE BOTON GN-481	4
CON RIEL ADICIONAL AGREGAR:		
3879	ESCUADRA DE BOTON GN- 467	4

FIJOS SERIE 80

CLAVE	DESCRIPCION	PZS
3878	ESCUADRA DE BOTON GN-481	4
3922	TAPA DREN CON VALVULA GN-554	2
3941	VINIL EP-126 AMBOS LADOS Ó	
3944	VINIL 2610 UN SOLO LADO	

CORREDIZA SERIE 150 XX

CLAVE	DESCRIPCION	PZS
3839	CANDADO DE HOJA GN-623	4
3844	CARRETILLA 110 K GN-622CA	4
3850	CIERRE EMBUTIDO S-150	2
3863	CORTAVIENTOS GN-622 CV	2
3878	ESCUADRA DE BOTON GN-481	12
3876	ESCUADRA DE ALINEACION GN-608	16
3894	JALADERA BRIO SOBREPUESTA GN-560	2
3921	TAPON DESAGUE GN-105	1
3922	TAPA DREN CON VALVULA GN-554	2
3920	TAPA TRASLAPE GN-622 TT	4
3889	FELPA CON PLASTICO FN-110	
3944	VINIL E-2610	
NOTA**		
EN TRIPLE RIEL AGREGAR:		
3878	ESCUADRA DE BOTON GN-481	4
CON RIEL ADICIONAL AGREGAR:		
3879	ESCUADRA DE BOTON GN- 467	4



Si necesita algún perfil especial,
con gusto se lo cotizamos y le brindamos
la asesoría técnica que necesite.

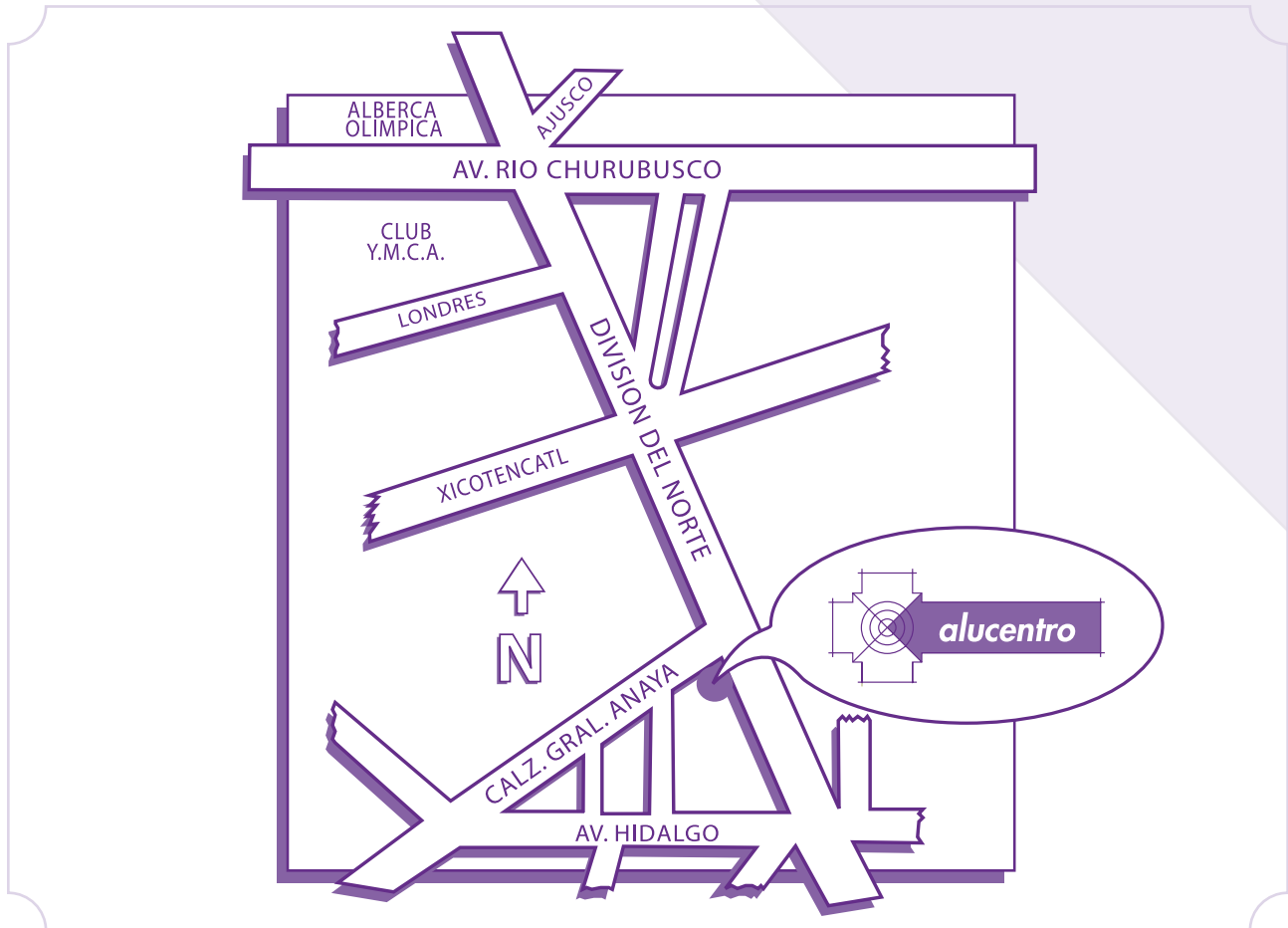

WhatsApp  55 5658-1700

División del Norte #2639

Col. del Carmen, Coyoacán

 55 5658-1700 • 55 5658-1030 • 55 5658-0422 • 55 5658-0440

ventas@alucentro.mx

 www.alucentro.mx

Horario

Lunes a viernes de 8:30 AM a 6:00 PM, sábados de 8:30 AM a 1:15 PM